

COLOR LUX™

— Designer Cellular & Roller Shades —

800 COLORS AVAILABLE



2018

Manufacturer's Price List and Reference Guide | Effective April 1st

MDS Midwest
WINDOW FASHIONS Designer
Supply

www.midwestdesignersupply.com

888-523-2611
262-524-1007 (fax)



Comfortex
WINDOW FASHIONS

Comfortex Color Lux® Cellular, Roller and Panel Track Shades

Price List and Reference Guide

Effective April 1, 2018 - Updated April 20, 2018

This price list and reference guide contains product pricing, product specifications and technical information for the complete line of Comfortex Color Lux Cellular, Roller and Panel Track Shades.

Color Lux Cellular Shades

Hardware Options	1-2
Hardware Upgrades and Surcharges.	3
Size Standards	4-6
Shade Stack Heights	7
Price Group 1: Standard Rectangular - Color Lux Linen Weave & Boutique Light Filtering	8
Price Group 2: Standard Rectangular - Color Lux Linen Weave & Boutique Room Darkening.	9
Price Group 3 & 4: Ovation™ Cellular Sliders - Color Lux Linen Weave & Boutique Light Filtering and Color Lux Linen Weave & Boutique Room Darkening.	10
Price Group 5 & 6: Starburst Non-Movable & Movable Arches - Non-Movable & Movable Quarter Rounds Color Lux Linen Weave & Boutique Light Filtering and Color Lux Linen Weave & Boutique Room Darkening	11
Price Group 7 & 8: Sunset™ Movable Arches - Color Lux Linen Weave & Boutique Light Filtering and Color Lux Linen Weave & Boutique Room Darkening	12
Price Group 9 & 10: Trapezoids and Octagons - Color Lux Linen Weave & Boutique light Filtering and Color Lux Linen Weave & Boutique Room Darkening	13
Price Group 11 & 12: Mezzo Motorized Skylights - Color Lux Linen Weave & Boutique Light Filtering and Color Lux Linen Weave & Boutique Room Darkening.	14
Price Group 13 & 14: Non-Movable Door Decor - Color Lux Linen Weave & Boutique Light Filtering and Color Lux Linen Weave & Boutique Room Darkening	15
Price Group 15 & 16: Movable Door Decor - Color Lux Linen Weave & Boutique Light Filtering and Color Lux Linen Weave & Boutique Room Darkening	16
Hardware - Standard Cord Lock Shades	17-18
Hardware - Cord Loop Hardware System.	19-20
Hardware - Cordless Ultra™ Hardware System.	21-22
Hardware - Cordless Lift & Lock Hardware System.	23-24
Hardware - Ovation Cellular Sliders	25-26
Hardware - Motorized Shades (including Rechargeable Battery Motorization).	27-31
Hardware - NEW Motorized Top Down-Bottom Up Shades	32-33
Hardware - Simplicity Smart Controller	34
Hardware - PowerTouch Rechargeable Motorized Shades	35-36
Hardware - Simplicity Wave Rechargeable Motorized Shades	37-38
Hardware - Insulating SlumberShades	39-40
Hardware - NEW StrataView Shades.	41-42
Hardware - Starburst Arches.	43
Hardware - Quarter Rounds	44-45
Hardware - Sunset Arches	46-47
Hardware - Trapezoids and Octagons.	48-49
Hardware - Mezzo Motorized Skylight Shades	50-52
Hardware - Door Decor	53-54
Hardware - Day-Night Shades	55-56
Hardware - Highlights Cornice Valance	57

Color Lux Roller Shades

Key Features for Roller Hardware Options	59-60
Skyline Hardware Roller Shades	61-63
Price Group 17: Standard Rectangular - Color Lux Classic Duck Light Filtering	64
Price Group 18: Standard Rectangular - Color Lux Classic Duck Blackout	63
Price Group 19: Standard Rectangular - Color Lux Linen Light Filtering	66
Price Group 20: Standard Rectangular - Color Lux Linen Blackout	67
Price Group 21: Standard Rectangular - Color Lux Solar Screen 5	68
Color Lux Fabric Information and Fire Rating	69
Hardware Details - Skyline Standard Roller	70
Hardware Details - Cordless Roller with Deco-Bar	71
Hardware - Designer Cassette with Insert Strip	72
Hardware - Designer Cassette with Fabric Wrap	73
Hardware - Designer Cassette with Smooth Face	74
Hardware - Designer Cassette with Retractable Cord	75
Hardware - Four Inch Skyline Fascia	76
Hardware - Dual Roller with Skyline Hardware	77
Highlights Cornice Valance with Keystone	78-80
Designer Cassette with Retractable Cord	81
Dual Roller Shades with Skyline Hardware	82
Two-on-One Head Rail	83
Two-on-One No Head Rail and Side by Side Mounting with Skyline Hardware	83
Cordless Operation Options	84
Tassels and Pulls	85
Cord Loop Operation Options	86
Skyline Hardware Tensioner Information	86
General Information	87
Simplicity Rechargeable Wave	88
Power Touch Rechargeable	89-90
Simplicity Motorization (Including Simplicity Rechargeable Motorization)	91-94
Simplicity 6 Channel Timer Remote Information	95

Color Lux Panel Track System Shades

Features and Benefits of the Panel Track System	97
Stacking Options	97
Panel Attachment Method	97
Head Rail Colors	97
Bottom Rail Style	97
Fabric Panel Information	97
Panel Custom Overlaps	97
Control Options	98
Panel Widths	98
Head Rail Splicing	98
Track Specifications	98
Grid #22 & 23: Includes Classic Duck Light Filtering, Classic Duck Blackout, Linen Light Filtering, Linen Blackout, and Solar Screen 5	99
Finished Dimensions	100

Mounting Options	100
Panel Stack Back	100
Light Gap	100
Fabric Deductions and Specifications	100
Highlights Valance	100
Clear Window Opening and Stack Panels	101
Outside Mount Hardware Profiles	102
Inside Mount Hardware Profiles	103

Color Lux Custom Graphics - Effective July 1, 2017

General Information and How to Order	104-105
Pricing	106-107

Color Lux General Information

Cut-Outs, Scotchgard™ Protection and Certified Fabrics	109
Highlights Cornice Valances	109
Stack Heights	109
Child Safety	110
Cleaning and Care	110
Measuring Instructions	111
Making Template	111
Conditions of Sale	112
Policies	112
Motorized Color Lux Cellular Shades Warranty	112
Scotchgard™ Warranty	113
Color Lux Warranty Information	113-114

Color Lux® Cellular Shades



COLOR LUX
Designer Cellular & Roller Shades



Scotchgard™ Protection







Optional Scotchgard™ Protector is available with Color Lux Linen Shades. Scotchgard™ keeps your shades looking newer, fresher and cleaner longer.

A combination of the latest advances in stain release and repellency provides exceptional stain protection. Spills wipe away easily and most dirt and stains lift out when cleaned.

Color Lux® Cellular Shade Hardware Options

COLOR LUX® CELLULAR SHADES



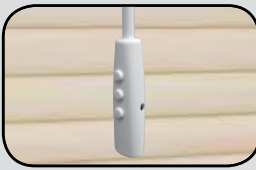



COLOR LUX® CELLULAR SHADES

	Key Features	Hardware Options	Hardware Size (Depth x Height)	Shade Size Available*	More Information
Standard Cord Lock 	<ul style="list-style-type: none"> • Proven cord lock • Sleek, fabric wrapped rails • UV resistant cords 	<ul style="list-style-type: none"> • Fabric Wrapped • Brushed Nickel • Oil Rubbed Bronze 	2 ³ / ₈ " x 1/2"	Width: 8" to 108" Length: 8" to 120"	Page 17
Cord Loop 	<ul style="list-style-type: none"> • Cord Loop makes operation easy • Smooth & quiet operation 	<ul style="list-style-type: none"> • Fabric Wrapped • Brushed Nickel • Oil Rubbed Bronze 	2 ¹ / ₄ " x 1 ¹ / ₂ "	Width: 14" to 108" Length: 8" to 120"	Page 19
Cordless Ultra 	<ul style="list-style-type: none"> • Child safe • No visible cords • Smooth & quiet operation 	<ul style="list-style-type: none"> • Fabric Wrapped • Brushed Nickel • Oil Rubbed Bronze 	2 ¹ / ₄ " x 1 ¹ / ₂ "	Width: 18" to 96" Length: 8" to 84"	Page 21
Cordless Lift & Lock 	<ul style="list-style-type: none"> • Child safe • Easy push button operation • Rails lock securely in place in any position 	<ul style="list-style-type: none"> • Fabric Wrapped • Oil Rubbed Bronze 	2 ³ / ₈ " x 1/2" Bottom Rail: 1 ⁷ / ₈ " x 1 ¹ / ₈ "	Width: 16" to 96" Length: 8" to 84"	Page 23
Simplicity Motorization 	<ul style="list-style-type: none"> • Raise & lower shade with click of a button • Great for large and hard to reach windows • Remote can operate multiple shades 	<ul style="list-style-type: none"> • Fabric Wrapped • Oil Rubbed Bronze 	2 ¹ / ₄ " x 1 ¹ / ₂ "	Width: 18" to 96" Length: 8" to 120"	Page 27
Rechargeable Simplicity Motorization 	<ul style="list-style-type: none"> • Features a battery powered motor utilizing a rechargeable battery pack • Raise & lower shade with click of a button • Great for large and hard to reach windows • Remote can operate multiple shades 	<ul style="list-style-type: none"> • Fabric Wrapped • Oil Rubbed Bronze 	2 ¹ / ₄ " x 1 ¹ / ₂ "	Width: 18" to 96" Length: 8" to 120"	Page 29
PowerTouch Rechargeable 	<ul style="list-style-type: none"> • Raise & lower shade with push of a button • Eliminate the need to stand by the shade to operate; just touch and go • Favorite position button • Rechargeable battery pack with recharge port on pendant 	<ul style="list-style-type: none"> • Wand and pendant available in white or black 	2 ¹ / ₄ " x 1 ¹ / ₂ "	Width: 18" to 96" Length: 8" to 120"	Page 35

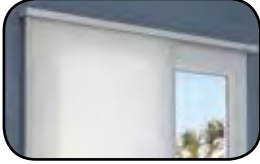
* Maximum widths and lengths listed do not take into account square foot or weight limitations. Make sure to refer to shaded areas on price groups for maximum size availability by fabric style.

Color Lux® Cellular Shade Hardware Options

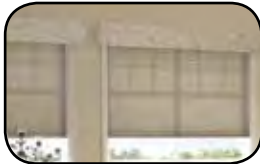
COLOR LUX® CELLULAR SHADES

	Key Features	Color Options	Hardware Size (Depth x Height)	Shade Size Available*	More Information
Simplicity Wave Rechargeable Motorization 	<ul style="list-style-type: none"> • Features a battery powered motor utilizing a rechargeable battery • Raise & lower shade with the wave of a wand • Great for out of reach windows • Exact match soft fabric wrapped rails 	<ul style="list-style-type: none"> • Fabric Wrapped 	2¼" x 1½"	Width: 17⅝" to 96" Length: 12" to 120"	Page 37
Ovation™ Slider 	<ul style="list-style-type: none"> • Vertically oriented fabric glides across window • Shade can stack left, right or center • Great for sliding glass doors or room dividers 	<ul style="list-style-type: none"> • White (Standard) • Ivory • Beige • Tan • Gray 	3⅜" x 1¼"	Width: 12" to 168" Length: 24" to 108"	Page 25
Door Décor 	<ul style="list-style-type: none"> • Great option for narrow windows and doors • Available in movable & non-movable rails • No Pull cords 	<ul style="list-style-type: none"> • Fabric Wrapped • Brushed Nickel • Oil Rubbed Bronze 	2⅜" x ½"	Width: 3" to 36" Length: 12" to 96"	Page 53
Top Down-Bottom Up 	<ul style="list-style-type: none"> • Lower shade from top: raise from bottom • Great for privacy • Ideal for light control • NEW! Motorization Available 	<ul style="list-style-type: none"> • Fabric Wrapped • Oil Rubbed Bronze 	2⅜" x ½"	Width: 18" to 108" Length: 8" to 120"	See Product Availability Page 17-24
Two on One Head Rail 	<ul style="list-style-type: none"> • Operate two shades on one rail • Great for larger windows • Individually operating shades 	<ul style="list-style-type: none"> • Fabric Wrapped • Oil Rubbed Bronze 	Dependent on Hardware Chosen See Above	Width: 16" to 144" Length: 8" to 120"	See Product Availability Page 17-20
Highlights Cornice Valance 	<ul style="list-style-type: none"> • Adds height to windows and hides hardware • Available as inside and outside mount • Easy to install 	<ul style="list-style-type: none"> • All Color Lux Roller Fabrics • All Envision Roller Fabrics 	Width: 24" to 216" Height: 6" Returns: 1½" to 6"	Varies by selected fabric Width: 12" to 94"	Page 59
Insulating SlumberShade™ 	<ul style="list-style-type: none"> • Ultimate blackout shade • Tracks keep out light, cold or heat • Perfect for nurseries, day sleepers • Note: Not available on Boutique fabrics 	<ul style="list-style-type: none"> • Fabric Wrapped • Brushed Nickel • Oil Rubbed Bronze • Sidetracks are available in white, tan or black 	Dependant on hardware choice	Width: 9" to 96" Length: 8" to 120"	Page 39

* Maximum widths and lengths listed do not take into account square foot or weight limitations. Make sure to refer to shaded areas on price groups for maximum size availability by fabric style.

Cellular Shade **Non-Motorized** Hardware Upgrade Options

LIFT SYSTEM	UPGRADES	ADD	DESIGNER UPGRADE OPTIONS	UPGRADES	ADD
Cord Lock	Top Down-Bottom Up	\$64	Add to Any Lift System Upgrade (Chart to the left)	Metallic Hardware	No Extra Charge
	Cordless Lift & Lock Surcharge	Bottom Up		Fabric Wrapped Hardware	No Extra Charge
	Top Down-Bottom Up	\$83		Scotchgard Stain Protection	\$35
Cordless Ultra	Bottom Up	\$83		Highlights Valance See Page 57 For More Information	
	Top Down-Bottom Up	\$166		Light Blocking Sidetrack System See Page 39 For More Information	Insulating SlumberShades
Cord Loop	Bottom Up	\$83			
	Top Down-Bottom Up	\$166			

ADDITIONAL OPTIONS	UPGRADES	ADD
Add to Any Upgrade Above	Two-On-One Head Rail	\$50 Add to Cord Lock, Cordless or Cord Loop Head Rail
	Cut Outs	\$52 Per side
	Day-Night	Price each panel as separate shade and add together
	StrataView™	\$345 (includes Top Down-Bottom Up & top sheer fabric additions) Available on Cordless Ultra and Cord Loop
	Ovation Center Stack	\$84
Accessories	6 Foot Expandable Pole	\$37
	12 Foot Expandable Pole	\$46

Cellular Shade **Motorized** Hardware Upgrade Options

MOTORIZED	UPGRADES	ADD	
PowerTouch Rechargeable Motorization System	Motor and Rechargeable Battery Pack	\$110	For More Information Page 33
	Plug-In Charger for Rechargeable Li-Ion	\$27	
Simplicity Remote Motorization System	Motor and Battery Wand	\$334	For More Information Page 27
	Simplicity 5 Channel Remote	\$40	
	Simplicity 6 Channel Remote/Timer	\$65	
	48" Extension Wire	\$18	
	DC Power Supply/Transformer	\$63	
Simplicity Remote Rechargeable Motorization System	Motor and Rechargeable Battery Pack	\$334	For More Information Page 29
	Simplicity 5 Channel Remote	\$40	
	Simplicity 6 Channel Remote/Timer	\$65	
	Plug-In Charger for Rechargeable Li-Ion	\$27	
	NEW StrataView™*	\$714	
	NEW Top Down-Bottom Up**	\$535	
	NEW Top Down-Bottom Up/StrataView 14 Channel Remote***	\$65	
7.4v Solar Panel & Mounting Brackets	\$75		
Simplicity Wave Rechargeable Motorization System	Motor and Rechargeable Battery Pack	\$110	For More Information Page 37
	Telescoping Wand	\$29	
	Plug-In Charger for Rechargeable Li-Ion	\$27	
Simplicity Smart Controller System	NEO Controller	\$330	For More Information Page 34
	NEO Application for Mobile Devices	FREE	

*Upcharge includes Top Down-Bottom Up surcharge & top sheer fabric addition \$179

**Upcharge includes motorization surcharge of \$334, plus \$201 for second motor and Top Down-Bottom Up components

*** TDBU Remote required for Motorized Top Down-Bottom Up and StrataView shades

Color Lux® Cellular Shade Fabric Collections Size Standards

COLOR LUX® CELLULAR SHADES



				Cord Lock		Cord Loop		Cordless Ultra		Cordless Lift & Lock	
				Standard	TD-BU	Standard	TD-BU [†]	Standard	TD-BU [†]	Standard	TD-BU
COLOR LUX® FABRICS				Minimum							
				Min. Width	8" 12"	14" 22"	15" OB 18" OB 15 3/8" IB 18 3/8" IB	16" OB 20" OB 16 3/8" IB 20 3/8" IB			
				Min. Length	8" 8"	8" 8"	8" 8"	8" 8"			
*				Cord Lock		Cord Loop		Cordless Ultra		Cordless Lift & Lock	
				Standard	TD-BU	Standard	TD-BU [†]	Standard	TD-BU [†]	Standard	TD-BU
Linen Weave & Boutique	Price Group	Page									
Light Filtering	1	8	Maximum Width & Length	108" width 120" length	96" width 96" length	108" width 120" length	108" width 120" length	108" width 84" length	96" width 84" length	96" width 84" length	96" width 84" length
Room Darkening	2	9	Maximum Width & Length	108" width 120" length	84" width 96" length	108" width 120" length	108" width 120" length	108" width 84" length	96" width 84" length	96" width 84" length	96" width 84" length
				Cord Lock		Cord Loop		Cordless Ultra		Cordless Lift & Lock	
				Standard	TD-BU	Standard	TD-BU	Standard	TD-BU	Standard	TD-BU
Stacking Heights Information On Page				Page 7		Page 7		Page 7		Page 7	
More Information On Page				Page 17		Page 19		Page 21		Page 23	

+ Maximum Width & Length and Minimum Width & Length applies to StrataView Shades

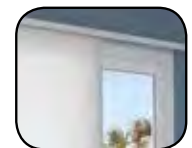

				Motorization		Motorization		Two-On-One Head Rail		Ovation
				Simplicity+	Simplicity Wave	PowerTouch Rechargeable	Cord Lock*	Cord Loop/Cordless**	Standard	
COLOR LUX® FABRICS				Minimum						
				Minimum Width	18" OB 18 3/8" IB	17 3/8"	18" OB 18 3/8" IB	16" 36"	12"	
				Min. Length	8" 12"	8"	8" 8"	8" 8"	24"	
				Motorization		Motorization		Two-On-One Head Rail		Ovation
				Simplicity~	Simplicity Wave	PowerTouch Rechargeable	Cord Lock*	Cord Loop/Cordless**	Standard	
Linen Weave & Boutique										
Light Filtering			Maximum Width & Length	108" width 120" length	96" width 120" length	108" width 120" length	144" width 120" length	144" width 120" length	120" width*** 108" length	
Room Darkening			Maximum Width & Length	108" width 120" length	96" width 120" length	108" width 120" length	144" width 120" length	144" width 120" length	120" width*** 108" length	
				Motorization		Motorization		Two-On-One Head Rail		Ovation
				Simplicity	Simplicity Wave	PowerTouch Rechargeable	Cord Lock	Cord Loop/Cordless	Standard	
Stacking Heights Information On Page				Page 7		Page 7		Page 7		Page 7
More Information On Page				Page 27-31		Page 35		Page 17-21		Page 25

Maximum widths and lengths listed do not take into account square foot or weight limitations. Make sure to refer to shaded areas on price groups for maximum size availability by fabric style. * Minimum single panel is 8", maximum single panel is 108". ** Minimum single panel is 18", maximum single panel is 108".*** Split stack sliders are available is 240", however if the width exceeds 120", the shade will be fabricated as two separate sliders. Supplied valance will create the appearance of a single slider. + Minimum for Motorized Top Down-Bottom Up is 24" IB and 23 3/8" OB. Minimum length and maximum length and width are the same as Simplicity motorization specs.

Color Lux® Cellular Shade Fabric Collections Size Standards



	Minimum	SlumberShade Cord Lock		SlumberShade Cord Loop		SlumberShade Cordless	
		Bottom Up	Top Down Bottom Up	Bottom Up	Top Down Bottom Up	Bottom Up	Top Down Bottom Up
LINEN WEAVE FABRICS (not available in Boutique fabrics)	Minimum Width	9"	13"	15"	25"	16" IB	19"
	Min. Length	8"	8"	8"	8"	8"	8"

Light Filtering	Price Group	Page		SlumberShade Cord Lock		SlumberShade Cord Loop		SlumberShade Cordless	
				Bottom Up	Top Down Bottom Up	Bottom Up	Top Down Bottom Up	Bottom Up	Top Down Bottom Up
Linen Weave	1	8	Maximum Width & Length Refer to shaded area in price grids for max size (sq ft) by fabric style	96" width 120" length	96" width 96" length	96" width 120" length	96" width 120" length	96" width 84" length	96" width 84" length

Room Darkening & Blackout	Price Group	Page		SlumberShade Cord Lock		SlumberShade Cord Loop		SlumberShade Cordless	
				Bottom Up	Top Down Bottom Up	Bottom Up	Top Down Bottom Up	Bottom Up	Top Down Bottom Up
Linen Weave	2	9	Maximum Width & Length Refer to shaded area in price grids for max size (sq ft) by fabric style	96" width 120" length	84" width 96" length	96" width 120" length	96" width 120" length	96" width 84" length	96" width 84" length

	SlumberShade Cord Lock		SlumberShade Cord Loop		SlumberShade Cordless	
	Bottom Up	Top Down Bottom Up	Bottom Up	Top Down Bottom Up	Bottom Up	Top Down Bottom Up
Stacking Heights Information On Page More Information On Page	Page 7 Page 39-40		Page 7 Page 39-40		Page 7 Page 39-40	

Please Note: For any shades under 12" width, the maximum height is 80".

SIMPLICITY MOTORIZATION PRICING EXAMPLE:

Linen Weave Light Filtering 42" x 60" Shade:	\$386.00
Simplicity Motor Surcharge:	\$334.00
Simplicity Remote Control:	\$40.00
Total List Price:	\$760.00

SIMPLICITY RECHARGEABLE MOTORIZATION PRICING EXAMPLE:

Linen Weave Light Filtering 42" x 60" Shade:	\$386.00
Simplicity Rechargeable Surcharge:	\$334.00
Plug-In Charger for Battery (required):	\$27.00
Simplicity Remote Control:	\$40.00
Total List Price:	\$787.00

STRATAVIEW MOTORIZATION PRICING EXAMPLE:

Linen Weave Light Filtering 42" x 60" Shade:	\$386.00
Simplicity Rechargeable Surcharge:	\$714.00
Plug-In Charger for Battery (required):	\$27.00
StrataView Remote Control:	\$65.00
Total List Price:	\$1192.00

Color Lux® Cellular Shade Fabric Collections Size Standards

COLOR LUX® CELLULAR SHADES

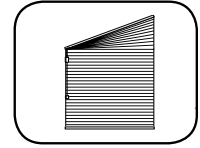
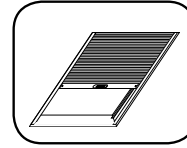
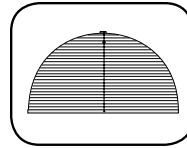
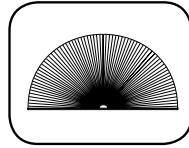

		Starburst Arch	Sunset Arch	Mezzo Skylight	Trapezoid
		Non-Movable/Movable	Movable	Motorized	Standard
COLOR LUX® FABRICS	Minimum				
	Min. Width	18"	18"	18"	12"
	Min. Length	9"	6"	12"	12"
		Starburst Arch	Sunset Arch	Mezzo Skylight	Trapezoid
		Non-Movable/Movable	Movable	Motorized	Standard
Linen Weave & Boutique					
Light Filtering	Maximum Width & Length	72" x 36"	72" x 60"	48" x 72"	48" x 72"
Room Darkening	Maximum Width & Length	72" x 36"	60" x 60"	48" x 72"	48" x 72"
		Starburst Arch	Sunset Arch	Mezzo Skylight	Trapezoid
		Non-Movable/Movable	Movable	Motorized	Standard
Stacking Heights Information On Page More Information On Page		Page 7 Page 43	Page 7 Page 46	Page 7 Page 50	Page 7 Page 48

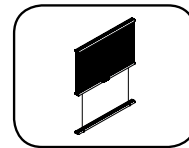
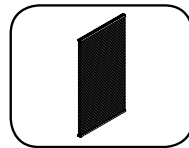
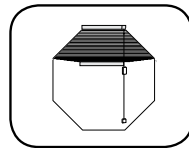

		Octagon	French Door Décor	
		Standard	Non-Movable	Movable
COLOR LUX® FABRICS	Minimum			
	Minimum Width	12"	6"	6"
	Min. Length	12"	12"	12"
		Octagon	Door Decor	
		Standard	Non-Movable	Movable
Linen Weave & Boutique				
Light Filtering	Maximum Width & Length	48" width 48" length	36" width 96" length	36" width 96" length
Room Darkening	Maximum Width & Length	48" width 48" length	36" width 96" length	36" width 96" length
		Octagon	Door Decor	
		Standard	Non-Movable	Movable
Stacking Heights Information On Page More Information On Page		Page 7 Page 48	Page 7 Page 53	Page 7 Page 53

Shade Stack Heights

Measurements are in inches. Shade stacking heights applicable when the shade is in the fully raised position.

RECTANGULAR CORD LOCK - Includes head and bottom rails	48"	72"	84"	96"
Linen Weave & Boutique Light Filtering and Room Darkening Fabrics	2"	2 ³ / ₈ "	2 ⁵ / ₈ "	2 ⁷ / ₈ "

For Top Down-Bottom Up, add ⁵/₈"

CORD LOOP - CORDLESS ULTRA - MOTORIZATION - Includes head and bottom rails	48"	72"	84"	96"
Linen Weave & Boutique Light Filtering and Room Darkening Fabrics	3"	3 ³ / ₈ "	3 ⁵ / ₈ "	3 ⁷ / ₈ "
StrataView™	4 ⁵ / ₈ "	5 ¹ / ₂ "	6"	6 ¹ / ₂ "

CORDLESS LIFT & LOCK - Includes head and bottom rails	48"	60"	72"	84"
Linen Weave & Boutique Light Filtering and Room Darkening Fabrics	2 ³ / ₄ "	3 ¹ / ₈ "	3 ³ / ₈ "	3 ⁵ / ₈ "

For Top Down-Bottom Up, add 1¹/₄"

OVATION	84"	96"	108"	120"
Linen Weave & Boutique Light Filtering and Room Darkening Fabrics	6 ¹ / ₂ "	7 ¹ / ₄ "	8"	8 ³ / ₄ "

Ovations minimum fabric stack measures 6¹/₂" regardless of the ordered width. Fabric stacking dimensions are determined by the slider's hardware, not ordered width.



Color Lux® Linen Weave & Boutique Light Filtering

Price Group 1

Cord Lock - Fabric Wrapped or Designer Metallic Rails
Cordless Lift & Lock - Fabric Wrapped or Designer Metallic Rail

COLOR LUX® CELLULAR SHADES

		Width In Inches														
		24	30	36	42	48	54	60	66	72	84	96	108	120	132	144
Length In Inches	36	211	233	264	292	321	347	375	399	427	488	546	604	666	724	783
	42	224	254	282	316	347	377	410	439	470	537	602	668	737	804	866
	48	236	270	306	340	375	408	442	479	513	585	657	730	806	878	951
	54	252	285	324	362	401	438	475	515	555	632	714	792	875	957	1035
	60	266	304	347	386	426	469	509	553	596	678	765	853	940	1029	1118
	66	278	321	367	410	454	499	543	589	635	727	823	917	1013	1104	1200
	72	292	335	386	436	482	531	580	628	675	774	878	979	1083	1182	1285
	78	306	356	405	453	510	558	611	665	717	822	933	1040	1148	1258	1363
	84	315	368	424	479	534	585	642	697	752	863	981	1092	1212	1323	1440
	90	328	384	442	499	559	617	674	733	797	914	1034	1154	1276	1399	1520
96	340	399	463	521	583	644	706	767	829	955	1084	1210	1342	1464	1593	
108	368	430	499	564	636	700	770	837	908	1044	1185	1323	1467	1608	1747	
120	392	464	539	611	691	761	835	912	983	1135	1289	1442	1594	1750	1901	

Motorized Lift Systems are not offered within the shaded area.

Widths over 108" must be built as Two-On-One Shades. Surcharge is included in shades over 108" wide

LIFT SYSTEM	UPGRADES	ADD
Cord Lock	Top Down-Bottom Up	\$64
Cordless Lift & Lock Surcharge	Bottom Up	No Extra Charge
	Top Down-Bottom Up	\$83
Cordless Ultra	Bottom Up	\$83
	Top Down-Bottom Up	\$166
Cord Loop	Bottom Up	\$83
	Top Down-Bottom Up	\$166

DESIGNER UPGRADE OPTIONS	UPGRADES	ADD
Add to Any Lift System Upgrade (Chart to the left)	Metallic Hardware	No Extra Charge
	Fabric Wrapped Hardware	No Extra Charge
	Scotchgard Stain Protection	\$35
	Highlights Valance See Page 57 For More Information	

ADDITIONAL OPTIONS	UPGRADES	ADD
Add to Any Upgrade Above	Two-On-One Head Rail	\$50 Add to Cord Lock, Cord Loop, or Cordless Head Rail under 108" widths
	Cut Outs	\$52 Per side
	Day-Night	Price each panel as separate shade and add together
	StrataView™	\$345 (includes Top Down-Bottom Up & top sheer fabric additions)
Accessories	6 Foot Expandable Pole	\$37
	12 Foot Expandable Pole	\$46

MOTORIZATION	MORE INFO
Motorized Pricing Examples - Surcharges - Options	Pg 3
Insulating SlumberShades	\$134 See Page 39 For More Information. Not available with motorization or StrataView.

Color Lux® Linen Weave & Boutique Room Darkening

Price Group 2

Cord Lock - Fabric Wrapped or Designer Metallic Rails
Cordless Lift & Lock - Fabric Wrapped or Designer Metallic Rail

		Width In Inches														
		24	30	36	42	48	54	60	66	72	84	96	108	120	132	144
Length In Inches	36	275	303	344	380	418	452	488	519	556	635	710	786	916	992	1068
	42	292	331	367	411	452	491	533	571	611	699	783	869	1009	1096	1176
	48	307	351	398	442	488	531	575	623	667	761	855	949	1098	1192	1287
	54	328	371	422	471	522	570	618	670	722	822	929	1030	1188	1295	1396
	60	346	396	452	502	554	610	662	719	775	882	995	1109	1272	1388	1504
	66	362	418	478	533	591	649	706	766	826	946	1070	1193	1367	1486	1610
	72	380	436	502	567	627	691	754	817	878	1007	1142	1273	1458	1587	1721
	78	398	463	527	589	663	726	795	865	933	1069	1213	1352	1543	1686	1822
	84	410	479	552	623	695	761	835	907	978	1122	1276	1420	1626	1770	1922
	90	427	500	575	649	727	803	877	953	1037	1189	1345	1501	1709	1869	2026
	96	442	519	602	678	758	838	918	998	1078	1242	1410	1573	1795	1954	2121
	108	479	559	649	734	827	910	1001	1089	1181	1358	1541	1720	1958	2141	2322
120	510	604	701	795	899	990	1086	1186	1278	1476	1676	1875	2123	2325	2522	

Motorized Lift Systems are not offered within the shaded area.

Widths over 108" must be built as Two-On-One Shades. Surcharge is included in shades over 108" wide

LIFT SYSTEM	UPGRADES	ADD
Cord Lock	Top Down-Bottom Up	\$64
Cordless Lift & Lock Surcharge	Bottom Up	No Extra Charge
	Top Down-Bottom Up	\$83
Cordless Ultra	Bottom Up	\$83
	Top Down-Bottom Up	\$166
Cord Loop	Bottom Up	\$83
	Top Down-Bottom Up	\$166

DESIGNER UPGRADE OPTIONS	UPGRADES	ADD
Add to Any Lift System Upgrade (Chart to the left)	Metallic Hardware	No Extra Charge
	Fabric Wrapped Hardware	No Extra Charge
	Scotchgard Stain Protection	\$35
	Highlights Valance See Page 57 For More Information	

ADDITIONAL OPTIONS	UPGRADES	ADD
Add to Any Upgrade Above	Two-On-One Head Rail	\$50 Add to Cord Lock, Cord Loop or Cordless Head Rail under 108" widths
	Cut Outs	\$52 Per side
	Day-Night	Price each panel as separate shade and add together
	StrataView™	\$345 (includes Top Down-Bottom Up & top sheer fabric additions)
Accessories	6 Foot Expandable Pole	\$37
	12 Foot Expandable Pole	\$46

MOTORIZATION	MORE INFO
Motorized Pricing Examples - Surcharges - Options	Pg 3
Insulating SlumberShades	\$134 See Pages 41-42 For More Information

Color Lux® Linen Weave & Boutique Light Filtering

Price Group 3
Ovation Cellular Slider

Width In Inches

Length In Inches	Width In Inches																
	24	30	36	42	48	54	60	66	72	78	84	96	120	132	144	156	168
36	464	502	547	588	623	664	707	744	785	829	865	937	1084	1158	1234	1311	1385
42	493	541	589	636	676	722	770	813	862	906	946	1029	1198	1286	1375	1462	1551
48	526	574	633	682	729	778	831	884	935	979	1031	1128	1312	1408	1506	1602	1700
54	555	613	673	730	779	834	889	951	1008	1060	1116	1219	1425	1533	1639	1748	1855
60	587	648	712	775	831	891	954	1019	1080	1138	1196	1313	1537	1657	1774	1892	2012
66	620	687	756	823	884	950	1014	1089	1152	1219	1275	1408	1652	1775	1902	2027	2152
72	654	724	797	872	942	1009	1077	1157	1226	1298	1360	1507	1769	1910	2052	2194	2332
78	687	763	842	922	995	1069	1141	1228	1301	1377	1444	1597	1880	2029	2177	2329	2478
84	722	801	883	973	1051	1128	1206	1295	1377	1456	1527	1692	1991	2152	2309	2468	2625
90	753	839	930	1022	1102	1186	1273	1368	1451	1535	1615	1788	2110	2285	2461	2636	2811
96	784	876	974	1070	1155	1242	1340	1437	1527	1617	1699	1884	2222	2402	2582	2764	2943
108	814	911	1016	1120	1207	1301	1404	1504	1601	1699	1782	1982	2334	2517	2703	2887	3072

Color Lux® Linen Weave & Boutique Room Darkening

Price Group 4
Ovation Cellular Slider

Width In Inches

Length In Inches	Width In Inches																
	24	30	36	42	48	54	60	66	72	78	84	96	120	132	144	156	168
36	604	653	712	765	810	864	920	968	1021	1078	1125	1219	1410	1506	1605	1705	1801
42	641	704	766	827	879	939	1001	1057	1121	1178	1230	1338	1558	1672	1788	1901	2017
48	684	747	823	887	948	1012	1081	1150	1216	1273	1341	1467	1706	1831	1958	2083	2210
54	722	797	875	949	1013	1085	1156	1237	1311	1378	1451	1585	1853	1993	2131	2273	2412
60	764	843	926	1008	1081	1159	1241	1325	1404	1480	1555	1707	1999	2155	2307	2460	2616
66	806	894	983	1070	1150	1235	1319	1416	1498	1585	1658	1831	2148	2308	2473	2636	2798
72	851	942	1037	1134	1225	1312	1401	1505	1594	1688	1768	1960	2300	2483	2668	2853	3032
78	894	992	1095	1199	1294	1390	1484	1597	1692	1791	1878	2077	2444	2638	2831	3028	3222
84	939	1042	1148	1265	1367	1467	1568	1684	1791	1893	1986	2200	2589	2798	3002	3209	3413
90	979	1091	1209	1329	1433	1542	1655	1779	1887	1996	2100	2325	2743	2971	3200	3427	3655
96	1020	1139	1267	1391	1502	1615	1742	1869	1986	2103	2209	2450	2889	3123	3357	3594	3826
108	1059	1185	1321	1456	1570	1692	1826	1956	2082	2209	2317	2577	3035	3273	3514	3754	3994

PRODUCT INFORMATION		
	See Page 25 for detailed information.	
DESIGN UPGRADES		
	Scotchgard Stain Protector	Add \$35 per shade
	Center Stack	Add \$84 Left or Right Stack Standard
	Split Stack*	Price by dividing the full width measurement in half. Price as two separate units and add together.
	Dual Panel**	Price as two separate units and add together.

* Split stack sliders are available in widths up to 240". If the width exceeds 120", it will be fabricated as two separate sliders. The supplied valance will create the appearance of a single slider.

** A Dual Panel Stack Slider has a center opening design with a different fabric on each side, each of which can span the full width of the window. Both panels will be of equal width unless otherwise specified.

Color Lux® Linen Weave & Boutique Light Filtering

Price Group 5
Starburst Arches
Quarter Rounds

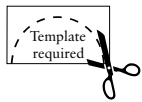

For widths wider than 58"

Fabric Wrapped or Designer Metallic Hardware Included

	Width In Inches								
	24	30	36	42	48	54	60	66	72
Non-Movable Starburst	271	305	344	389	462	526	591	664	745
Movable Starburst	375	422	478	537	638	712	799	891	992
Non-Movable Quarter Rounds	344	389	441	500	565	640			
Movable Quarter Rounds	462	521	589	662	745				

COLOR LUX® CELLULAR SHADES

Color Lux® Linen Weave & Boutique Room Darkening

Price Group 6
Starburst Arches
Quarter Rounds

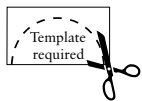

For widths wider than 58"

Fabric Wrapped or Designer Metallic Hardware Included

	Width In Inches								
	24	30	36	42	48	54	60	66	72
Non-Movable Starburst	375	419	470	528	623	706	791	886	991
Movable Starburst	510	571	644	721	852	948	1061	1181	1312
Non-Movable Quarter Rounds	470	528	596	672	757	854			
Movable Quarter Rounds	623	700	788	883	991				

Non-Movable Starburst Product Information:

Templates required on non-perfect non-movable Starburst Arches. See page 41 for more information.
 Fabric wrapped rail is standard. There will be a splice in the center. A decorative rosette is supplied to cover the splice.

Pricing Information:

Price according to the largest radius measurement. If the height is greater than the width, take height multiplied by 2 and use that number to determine pricing.

FABRIC SURCHARGES		ADD
Scotchgard Stain Protector		\$35
PRICING INFORMATION		
Starburst Arches	Price according to the largest radius measurement. If the height is greater than the width, take height X 2 and use that number to determine pricing. Metallic rails available.	
Quarter Rounds	Price according to the largest radius measurement.	
HARDWARE UPGRADE SURCHARGES* AND ACCESSORIES		ADD
Metallic Hardware or Fabric Wrapped Rails		No Extra Charge
6 Foot Expandable Pole		\$37
12 Foot Expandable Pole		\$46

Color Lux® Linen Weave & Boutique Light Filtering

COLOR LUX® CELLULAR SHADES

Price Group 7
Sunset Movable Arches
Fabric Wrapped or Designer Metallic Hardware Included

		Width In Inches								
		24	30	36	42	48	54	60	66	72
Half Round		345	382	403	451	480	536	567	622	678
	36	441	481	503	537	560	599	617	648	678
	42	463	510	530	581	600	645	665	702	733
	48	490	537	565	615	637	674	714	751	790
	60	535	599	627	691	721	781	812	859	904

Sunset Product Information:

Templates required on non-perfect Sunset Arches. See page 43.

Color Lux® Linen Weave & Boutique Room Darkening

Price Group 8
Sunset Movable Arches
Fabric Wrapped or Designer Metallic Hardware Included

		Width In Inches						
		24	30	36	42	48	54	60
Half Round		442	490	518	580	618	691	731
	36	567	619	648	692	722	773	796
	42	596	657	683	749	774	832	858
	48	631	692	728	793	822	870	922
	60	689	773	809	892	931	1009	1049

Sunset Product Information:

Templates required on non-perfect Sunset Arches. See pages 45.

PRODUCT INFORMATION		
	See Page 44 for detailed information.	
DESIGN UPGRADES		
	Scotchgard Stain Protector	Add \$35 per shade
	6 Foot Expandable Pole	Add \$37
	12 Foot Expandable Pole	Add \$46

Color Lux® Linen Weave & Boutique Light Filtering

Price Group 9
Trapezoids and Octagons
Fabric Wrapped or Designer Metallic Hardware Included

COLOR LUX® CELLULAR SHADES

Length In Inches	Width In Inches						
	24	30	36	42	48	54	60
36	468	495	528	564	595	625	655
42	484	516	552	591	625	660	697
48	499	536	578	619	655	694	735
54	515	554	600	643	685	729	771
60	532	575	624	670	715	767	812
66	548	595	648	698	749	801	847
72	564	613	670	726	781	835	891

Color Lux® Linen Weave & Boutique Room Darkening

Price Group 10
Trapezoids and Octagons
Fabric Wrapped or Designer Metallic Hardware Included

Length In Inches	Width In Inches						
	24	30	36	42	48	54	60
36	602	637	680	727	767	806	845
42	623	665	711	762	806	852	900
48	643	691	745	799	845	896	949
54	663	714	774	830	884	942	996
60	685	741	805	865	923	991	1049
66	706	767	836	901	968	1035	1095
72	727	791	865	938	1009	1079	1152

PRODUCT INFORMATION	
	See page 48 for detailed information. Width, length and one side are required measurements for Octagon Shades. Trapezoid orders must be faxed in with a diagram that includes the measurements for 4 sides.
DESIGN UPGRADES	
Scotchgard Stain Protector	Add \$35 per shade

Color Lux® Linen Weave & Boutique Light Filtering

**Price Group 11
Mezzo Motorized Skylights
White Rail and White Track**

		Width In Inches				
		24	30	36	42	48
Length In Inches	36	420	475	528	590	639
	42	444	504	571	631	700
	48	467	540	605	675	749
	54	494	570	645	717	809
	60	512	601	680	761	867
	66	540	628	714	800	923
	72	570	664	745	831	974

Be sure to add the Simplicity motor surcharges and upgrades to the grid above.

Color Lux® Linen Weave & Boutique Room Darkening

**Price Group 12
Mezzo Motorized Skylights
White Rail and White Track**

		Width In Inches				
		24	30	36	42	48
Length In Inches	36	540	611	680	761	825
	42	571	649	736	814	904
	48	601	696	780	871	968
	54	636	735	832	926	1046
	60	659	775	878	983	1121
	66	696	810	922	1034	1194
	72	735	857	962	1074	1260

Be sure to add the Simplicity motor surcharges and upgrades to the grid above.

MOTORIZED	UPGRADES	ADD	
Simplicity Motorization System	Motor and Battery Wand	\$334	For More Information Page 27
	Simplicity 5 Channel Remote	\$40	
	Simplicity 6 Channel Remote/Timer	\$65	
	48" Extension Wire	\$18	
	DC Power Supply/Transformer	\$63	
	Solar Panel with brackets	\$75	
Simplicity Rechargeable Motorization System	Motor and Battery Wand	\$334	For More Information Page 29
	Simplicity 5 Channel Remote	\$40	
	Simplicity 6 Channel Remote/Timer	\$65	
	Plug-In Charger for Rechargeable Li-Ion	\$27	
Simplicity Smart Controller System	NEO Controller	\$330	For More Information Page 34
	NEO Application for Mobile Devices	FREE	

Color Lux® Linen Weave & Boutique Light Filtering

Price Group 13
Non-Movable Door Decors
Fabric Wrapped or Designer Metallic Hardware Included

		Width In Inches				
		12	18	24	30	36
Length In Inches	36	112	118	124	137	153
	42	118	125	131	147	162
	48	125	132	138	156	175
	54	131	138	145	163	186
	60	139	147	154	174	196
	66	145	153	161	184	209
	72	151	159	167	191	219
	78	158	167	175	201	228
	84	163	172	181	210	239
	90	170	179	188	218	249
	96	174	184	193	225	260

COLOR LUX® CELLULAR SHADES

Color Lux® Linen Weave & Boutique Room Darkening

Price Group 14
Non-Movable Door Decor
Fabric Wrapped or Designer Metallic Hardware Included

		Width In Inches				
		12	18	24	30	36
Length In Inches	36	140	147	155	172	192
	42	148	156	164	185	204
	48	156	165	173	196	221
	54	164	173	182	205	235
	60	175	184	194	220	248
	66	183	193	203	233	265
	72	190	200	211	242	278
	78	199	210	221	255	290
	84	206	218	229	266	304
	90	215	226	238	277	317
	96	220	233	244	286	331

PRODUCT INFORMATION		
	See Page 53 for detailed information.	
DESIGN UPGRADES		
	Scotchgard Stain Protector	Add \$35 per shade
	6 Foot Expandable Pole	Add \$37
	12 Foot Expandable Pole	Add \$46

Color Lux® Linen Weave & Boutique Light Filtering

Price Group 15
Movable Door Decors
Fabric Wrapped or Designer Metallic Hardware Included

		Width In Inches				
		12	18	24	30	36
Length In Inches	36	202	213	224	247	276
	42	213	225	236	265	292
	48	225	238	249	281	315
	54	236	249	261	294	335
	60	251	265	278	314	353
	66	261	276	290	332	377
	72	272	287	301	344	395
	78	285	301	315	362	411
	84	294	310	326	378	431
	90	306	323	339	393	449
96	314	332	348	405	468	

Color Lux® Linen Weave & Boutique Room Darkening

Price Group 16
Movable Door Decor
Fabric Wrapped or Designer Metallic Hardware Included

		Width In Inches				
		12	18	24	30	36
Length In Inches	36	252	265	279	309	347
	42	267	281	295	333	368
	48	281	297	312	354	398
	54	296	312	328	370	424
	60	315	332	349	396	447
	66	330	348	365	419	478
	72	342	360	379	436	501
	78	359	378	398	459	522
	84	371	393	412	480	548
	90	387	407	429	499	571
96	396	420	440	515	597	

PRODUCT INFORMATION		
	See Page 53 for detailed information.	
DESIGN UPGRADES		
	Top Down-Bottom Up	Add \$166
	Scotchgard Stain Protector	Add \$35 per shade
	6 Foot Expandable Pole	Add \$37
	12 Foot Expandable Pole	Add \$46

Color Lux® Cellular Shade Head Rail Options

STANDARD CORD LOCK SHADES



Cord Lock Rail

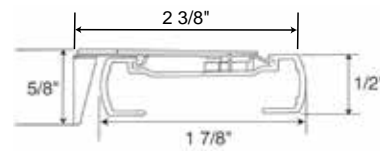

Cord Lock Rail

- Depth of rail: 1 7/8"
- Depth of rail and bracket: 2 3/8"
- Height: 1/2"
- Height of bracket: 5/8"

Hardware Features	
Fabric Wrapped	Fabric used is same fabric as the shade. Back of rail is white to outside. Color coordinated end caps with white cord and tassel
Designer Metallic	<ul style="list-style-type: none"> • Oil Rubbed Bronze head and bottom rails with bronze colored tassel, end caps and white cord. • Brushed Nickel head and bottom rails and end caps with coordinating tassel and white cord.
Mounting Dimensions	
	Cord Lock Rail
Minimum Shallow Mount	3/4"
Minimum Flush Inside Mount	2 3/8"
Minimum Outside Mount	3/4"
Minimum Side Mount	1 3/8"
Recommended Side Mounting Method	<ul style="list-style-type: none"> • See figure B for recommended mounting method for side mount shades • Width limit for side mount brackets is 48"
Finished Dimensions	
Inside and Side Mount	
	<ul style="list-style-type: none"> • Fabric will measure ordered width less: 3/8" • Head rail* will measure ordered width less: 3/16"
Outside Mount	
	<ul style="list-style-type: none"> • Fabric will measure ordered width • Head rail* will measure ordered width plus: 3/16"
Exact (End Cap to End Cap) Mount	
	<ul style="list-style-type: none"> • Fabric will measure ordered width less: 3/16" • Head rail* will measure ordered width
* Head rail measurements include endcaps. Width and length measurements may vary +/- 1/8"	

Color Lux® Cellular Shades STANDARD CORD LOCK SHADES

Applications

- Standard Rectangular
- Day-Night
- Trapezoids and Octagons
- Top Down - Bottom Up
- Two-On-One Head Rail

Highlights Cornice Valance

Add a designer finishing touch to a cellular shade with a Highlights Cornice Valance. See page 59 for details.

Things to Consider

- If child safety is a concern, consider cordless options: Cordless Ultra, Cordless Lift & Lock or Motorization.
- Larger shades can be difficult to operate. Consider Cord Loop, Cordless Ultra or Motorization hardware.
- If privacy is an issue, consider Top Down-Bottom Up options.

Recommended Mounting Method for Side Mount Shades

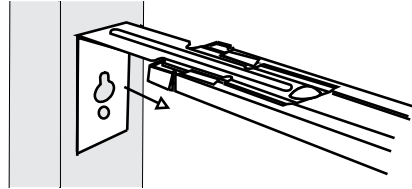

Figure B

EZ Level on Cellular Shades

EZ Level makes quick work of leveling without cords to cut or tuck into a rail. See page 59 for details.

Day-Night Shades

See pages 55-56 for more information.

Specialties (Trapezoids and Octagons)

See pages 48-49 for more information.



Color Lux® Cellular Shade Head Rail Options

CORD LOOP HARDWARE SYSTEM

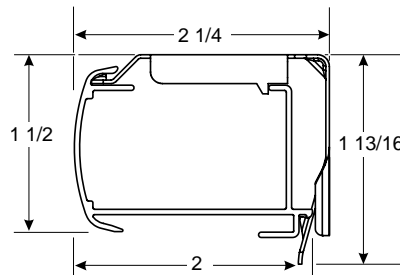

Cord Loop Rail Dimensions

- Depth of rail: 2"
- Depth of rail and bracket: 2 1/4"
- Height of rail: 1 1/2"
- Height of bracket: 1 13/16"

Hardware Features	
Fabric Wrapped	Fabric used is same fabric as the shade. Back of rail is white to outside. Clutch cover will be white. Frosted clear with fabric insert end caps with white cord.
Designer Metallic	<ul style="list-style-type: none"> • Oil Rubbed Bronze head and bottom rails with bronze colored end caps and cord. • Brushed Nickel head and bottom rails, end caps with white cord.

Mounting Dimensions	Cord Loop Hardware System
Minimum Shallow Mount	1/2"
Minimum Flush Inside Mount	2 1/4"
Minimum Outside Mount	7/8"
Minimum Side Mount	1 1/4"
Recommended Side Mounting Method	<ul style="list-style-type: none"> • See figure A for recommended mounting method for side mount shades • Width limit for side mount brackets is 48"

Finished Dimensions	
Inside Mount	
	<ul style="list-style-type: none"> • Fabric will measure ordered width less: 3/8" • Head rail* will measure ordered width less: 3/16"
Outside Mount	
	<ul style="list-style-type: none"> • Fabric will measure ordered width • Head rail* will measure ordered width plus: 3/16"
Side Mount	
	<ul style="list-style-type: none"> • Fabric will measure ordered width less: 7/8" • Head rail* will measure ordered width less: 1 1/16"
Exact (End Cap to End Cap) Mount	
	<ul style="list-style-type: none"> • Fabric will measure ordered width less: 3/16" • Head rail* will measure ordered width

* Head rail measurements include endcaps. Width and length measurements may vary +/- 1/8"

Color Lux® Cellular Shades

CORD LOOP SHADES

Applications

- Standard Rectangular
- Two-On-One Head Rail
- Top Down - Bottom Up

Cord Loop Hardware System Features

Cord loops are available 2' to 15' lengths in 1' intervals. Please specify length when ordering. Standard loop sizes are as follows:

Shade Length	Standard Loop
Up to and including 26 ⁷ / ₈ "	1' (12")
27" to 39 ⁷ / ₈ "	2' (24")
40" to 59 ⁷ / ₈ "	3' (36")
60" to 83 ⁷ / ₈ "	4' (48")
84" to 107 ⁷ / ₈ "	5' (60")
108" and greater	6' (72")

Recommended Mounting Method for Side Mounting Shades

Width limit for side mount brackets is 48".

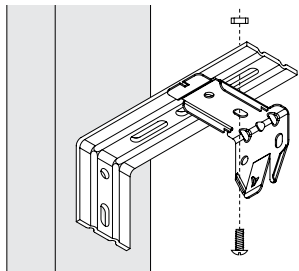

Cord Loop Hardware
Cordless Ultra Hardware
Cordless Ultra Top Down - Bottom Up Hardware

Figure A

Refer to the installation instructions on Comfortex.com/comfortex-dealers or the OnDemand Mobile Library for further details on side mounting shades.

Ordering Information for Cord Loop Hardware Shades

Standard Rectangular

- Specify IB or OB mount, rail color and left or right lift cord.
- Specify cord loop length when ordering.

Top Down - Bottom Up

- Specify IB or OB mount and rail color. Middle rail will match the top and bottom rails.
- Specify cord loop length when ordering.
- Controls are the right cord loop operates the middle rail and left cord loop operates the bottom. Reverse controls are not available.

Two-On-One Head Rail

- Two-On-One Head Rail Shades operate as two separate shades on one head rail.
- Specify IB or OB mount and rail color.
- Specify panel sizes.
- Specify cord loop length when ordering.
- ³/₈" Space between panels.
- Fabric wrapped Two-On-One Shades will have a seam in the center of the rail due to the wide width.

Highlights Cornice Valance

Add a designer finishing touch to a cellular shade with a Highlights Cornice Valance. See page 57 for details.

EZ Level on Comfortex Cellular Shades

EZ Level makes quick work of leveling without cords to cut or tuck into a rail. No special tools needed – just use a nickel, quarter or penny to adjust plug on the bottom rail.

EZ Level is standard on all Cellular and Pleated Shades with the following hardware systems:
Standard Cord Lock, Cordless Ultra, Cord Loop Simplicity Motorized Systems

EZ Level is not available with Cordless Lift & Lock.

How does EZ Level work?

- Slightly raise the bottom rail you want to level.
- Insert a coin or flat head screwdriver into the adjustment screw and turn it.
- Turn the adjustment screw clockwise or counter clockwise to make slight adjustments up or down. One quarter turn of the adjustment screw will move the bottom rail up or down ¹/₄".
- Lower the rail to check the level and make further adjustments if necessary.



Color Lux® Cellular Shade Head Rail Options

CORDLESS ULTRA HARDWARE SYSTEM

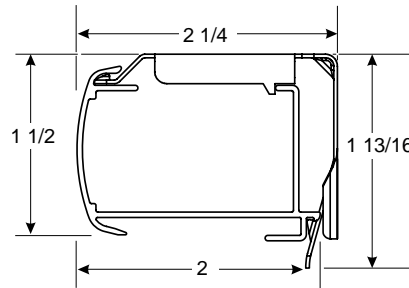

Cord Loop Rail Dimensions

- Depth of rail: 2"
- Depth of rail and bracket: 2 1/4"
- Height of rail: 1 1/2"
- Height of bracket: 1 13/16"

Hardware Features	
Fabric Wrapped	Fabric used is same fabric as the shade. Back of rail is white to outside. Frosted clear with fabric insert end caps with white cord.
Designer Metallic	<ul style="list-style-type: none"> • Oil Rubbed Bronze head and bottom rails with bronze colored end caps and cord. • Brushed Nickel head and bottom rails, end caps with white cord.

Mounting Dimensions	Cord Loop Hardware System
Minimum Shallow Mount	1/2"
Minimum Flush Inside Mount	2 1/4"
Minimum Outside Mount	7/8"
Minimum Side Mount	1 1/4"
Recommended Side Mounting Method	<ul style="list-style-type: none"> • See figure A, page 20 for recommended mounting method for side mount shades • Width limit for side mount brackets is 48"

Finished Dimensions	
Inside Mount	
	<ul style="list-style-type: none"> • Fabric will measure ordered width less: 3/8" • Head rail* will measure ordered width less: 3/16"
Outside Mount	
	<ul style="list-style-type: none"> • Fabric will measure ordered width • Head rail* will measure ordered width plus: 3/16"
Side Mount	
	<ul style="list-style-type: none"> • Fabric will measure ordered width less: 7/8" • Head rail* will measure ordered width less: 1 1/16"
Exact (End Cap to End Cap) Mount	
	<ul style="list-style-type: none"> • Fabric will measure ordered width less: 3/16" • Head rail* will measure ordered width

* Head rail measurements include endcaps. Width and length measurements may vary +/- 1/8"

Color Lux® Cellular Shades CORDLESS ULTRA SHADES

Applications

- Standard Rectangular
- Top Down - Bottom Up
- Two-On-One Head Rail

Things to Consider

- Is the top of your window out of reach? You can order an extension pole to reach but it can still be tricky. You may want to consider Cord Loop or Motorized hardware.
- For shades mounted on doors, you may want to order hold down brackets.
- If privacy is an issue, consider Top Down-Bottom Up options.

Ordering Information for Cordless Ultra Hardware Shades

Standard Rectangular

- Specify IB or OB mount and rail color.

Top Down - Bottom Up

- Specify IB or OB mount and rail color.
Middle rail will match the head and bottom rails.

Accessories

- 6' Expandable Pole: \$37.00
- 12' Expandable Pole: \$46.00

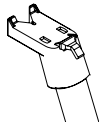

Specially designed pole end fits into the handle on the bottom rail and allows for easy operation.

Cordless Ultra and Cordless Ultra Top Down - Bottom Up Hardware Features

- Children and pets have safer surroundings in homes that have window shades without operating cords, reducing the risk of strangulation.
- Cordless Ultra and Cordless Ultra Top Down - Bottom Up Shades can be raised or lowered with a gentle push or pull on the rail handle.
- Cordless Ultra Top Down - Bottom Up Shades feature two moving rails.
- Order an operating pole for out of reach applications.



Fabric Wrapped Head Rail and Designer Metallic Head Rails.

Cordless Ultra Shade Operation

Cordless shades should be operated from the handle located in the center of the bottom rail. Using the handle will aid in smooth and easy shade operation. Two handles are supplied on wider width shades.

To lower the shade, pull down on the handle which is secured to the bottom rail and guide the rail to desired position (Figure A). For out of reach applications, an optional extension pole should be used.

To raise the shade, push the bottom rail up using the handle on the bottom rail and guide the rail to the desired position. The shade will hold any position when the bottom rail is released. Raise the shade slowly and steadily to allow the shade to stack evenly (Figure B).

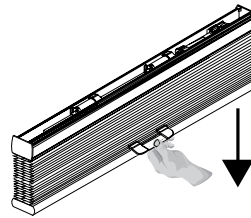

Figure A

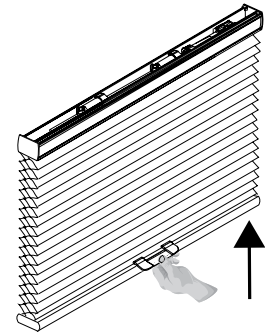

Figure B



Clear Cordless Handle

Recommended Mounting Method for Side Mounting Shades

See Page 20.

Highlights Cornice Valance

Add a designer finishing touch to a cellular shade with a Highlights Cornice Valance. See page 57 for details.

EZ Level on Cellular Shades

EZ Level makes quick work of leveling without cords to cut or tuck into a rail. See page 57 for details.

Color Lux® Cellular Shade Head Rail Options CORDLESS LIFT & LOCK HARDWARE SYSTEM



Cordless Lift & Lock Head Rail

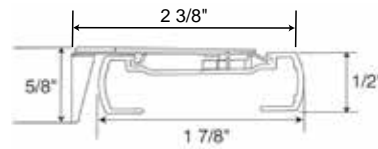

Cordless Lift & Lock Rail

- Depth of rail: 1 7/8"
- Depth of rail and bracket: 2 3/8"
- Height: 1/2"
- Height of bracket: 5/8"

Hardware Features	
Hardware	<ul style="list-style-type: none"> • Fabric wrapped head, middle and bottom rails. Shades will have a coordinated or white push button/handle and end caps on the middle/bottom rail. Refer to coordination chart in the Dealer Resource Center in the Fabrication section online. • Fabric used to cover the rails is the same fabric as the shade. The back of the rail will be white to the outside.
Upgrades	
Designer Metallic Upgrade	<ul style="list-style-type: none"> • Smooth faced Designer Oil Rubbed Bronze Metallic head, middle and bottom rail and end caps. • Oil Rubbed Bronze push button/handle on the middle and bottom rails.
Mounting Dimensions	
Lift & Lock Head Rail	
Minimum Shallow Mount	3/4"
Minimum Flush Inside Mount	2 1/2"
Minimum Outside Mount	3/4"
Minimum Side Mount	1 3/8"
Recommended Side Mounting Method	<ul style="list-style-type: none"> • See figure A (pg 20) for recommended mounting method for side mount shades • Width limit for side mount brackets is 48"
Finished Dimensions	
Inside and Side Mount	
	<ul style="list-style-type: none"> • Fabric will measure ordered width less: 3/8" • Head rail* will measure ordered width less: 3/16"
Outside Mount	
	<ul style="list-style-type: none"> • Fabric will measure ordered width • Head rail* will measure ordered width plus: 3/16"
Exact (End Cap to End Cap) Mount	
	<ul style="list-style-type: none"> • Fabric will measure ordered width less: 3/16" • Head rail* will measure ordered width
<p>* Head rail measurements include endcaps. Width and length measurements may vary +/- 1/8"</p>	

Color Lux® Cellular Shades CORDLESS LIFT & LOCK SHADES

Cordless Lift & Lock Shades Hardware System Bottom Rail Dimensions

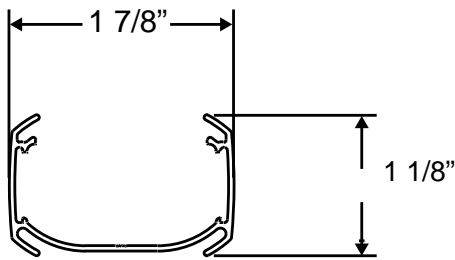

- Depth of rail: 1 7/8"
- Height of rail: 1 1/8"

Applications

- Standard Rectangular
- Top Down-Bottom Up

Important Operating Note on Cordless Lift & Lock Shades

- To operate a Cordless Lift & Lock Shade, the middle or bottom rails must be accessible. An extension pole is not available for Cordless Lift & Lock Shades.
- If the bottom or middle rail is not accessible, you may want to consider Cord Loop, Cordless Ultra or Motorized hardware. An extension pole is not available for Cordless Lift & Lock Shades.
- For shades mounted on doors, you may want to order hold down brackets.

Cordless Lift & Lock Hardware Features

- Children and pets have safer surroundings in homes that have window shades without operating cords, reducing the risk of strangulation.
- Cordless Lift & Lock Shades can be raised or lowered by pressing the button located on the bottom rail and guiding the rail into the desired location.

Leveling the Bottom Rails

Each Cordless Lift & Lock Shade includes a skew adjustment leveling tool hidden in the bottom rail of each shade.

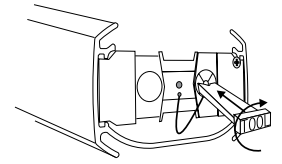

To level the bottom rail, remove the bottom rail end cap to access the tool which allows you to adjust the placement of the bottom rail. Adjustment instructions are supplied with each shade.

Ordering Information for Cordless Lift & Lock Shades

Standard Rectangular

- Specify IB or OB mount and rail color.

Cordless Lift & Lock Shade Operation

Cordless Lift & Lock Shades are operated using the push button handle located in the center of the bottom rail.

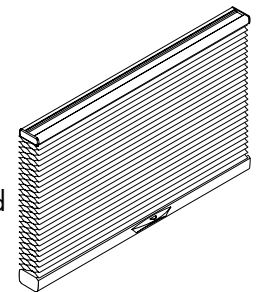

To raise or lower the shade; press the button on the shade handle, and guide the rail to desired position. Release the button to lock the shade into place.

The shade will in hold any position when the button is released. Raise the shade slowly and steadily to allow the shade to stack evenly.

Recommended Mounting Method for Side Mounting Shades

See Page 20.

Highlights Cornice Valance

Add a designer finishing touch to a cellular shade with a Highlights Cornice Valance. See page 57 for details.



Fabric Wrapped Head Rail with White End Caps



Fabric Wrapped Bottom Rail with White push button/handle



Oil Rubbed Bronze Head Rail and End Caps



Oil Rubbed Bottom Rail and push button/handle

Color Lux® Cellular Shade Head Rail Options

OVATION CELLULAR SLIDER

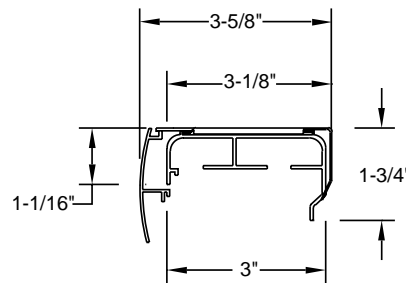

Ovation Hardware Rail Dimensions

- Depth of rail: 3"
- Depth of rail and bracket: 3 1/8"
- Height of rail: 1 3/4"

COLOR LUX® CELLULAR SHADES

Hardware Features	
Standard Hardware Color	Aspen White #785
Optional Hardware Colors	Ivory, beige, tan and gray rails are available as an option. Visit comfortex.com to view color options <ul style="list-style-type: none"> • Silverado #276 • Honey Bisque #882 • Camel #082 • Gardenia White #862

Mounting Dimensions	Ovation Hardware System
Minimum Inside Mount	3/4"
Minimum Flush Mount	3 5/8"
Minimum Outside Mount	5/8"

Finished Dimensions

Inside Flush Mount

Track Width:	
Right or Left Stack	3/16" less than ordered width
Split Stack	3/16" less than ordered width
Center Stack	3/16" less than ordered width
Finished Slider Length	1/2" less than ordered width
Valance	3/16" less than ordered width

Outside Mount

Track Width	Ordered width
Finished Slider Length	Ordered length - No reductions will be made
Valance	Ordered width plus 1 1/4"
Valance Returns	Will measure 3 1/8" (standard)

Color Lux® Cellular Shades OVATION CELLULAR SLIDER

Applications

- Standard Rectangular
- Opens and closes from side to side
- Four stacking options - see below.
- Dual Panel option with a center opening design with two fabrics, one on each side, each spanning the width of the window.

Ovation Stacking Options

Specify stacking configuration when ordering.

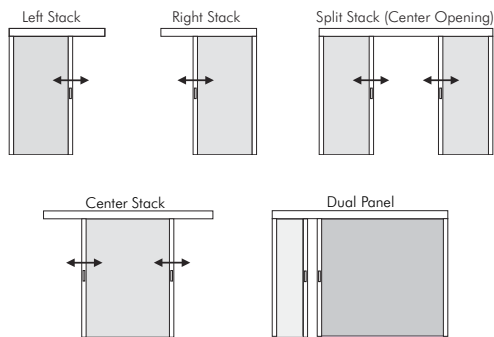

Left: Fabric stacks to the left side of the slider.

Right: Fabric stacks to the right side of the slider.

Center Stack: Center Stack Sliders fabric panels can move fully to the left or the right.

Split Stack: Fabric is split in the center of the slider forming two equal panels which open to opposite ends of the slider. Both panels will be of equal width unless otherwise specified. Split stack is not available with Gradient shades.

* Split stack sliders are available in maximum widths from 240" to 336" (maximum width depends on the fabric selected). If the width exceeds the maximum width of the fabric, it will be fabricated as two separate sliders. The supplied valance will create the appearance of a single slider.

Dual Panel: A Dual Panel Stack Slider has a center opening design with a different fabric on each side, each of which can span the full width of the window. Both panels will be of equal width unless otherwise specified. Specify which fabric stacks to left and which fabric stacks to the right.

Ordering Information for Ovation Cellular Sliders

- Specify IB or OB mount.
- Specify stacking configuration.
On Dual Panel Shades, specify which fabric stacks to the left and right.
On Split Stack Shades, both panels will be of equal width unless specified.
- Specify valance width and return length.

Ovation Valance Specifications

- Every Ovation Slider is supplied with a painted aluminum valance to match your hardware color choice.
- The valance attaches to the head rail using a durable plastic clip system.

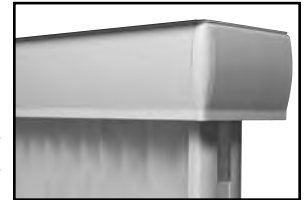

Ovation Valance Dimensions

All valance dimensions are measured on the flat, back side.

- Valance Height: 2¾"
- Standard Return Length (OB only): 3⅛"
- For each spacer block, ½" will be added to the length of the valance returns. For extension brackets, 2" will be added unless otherwise instructed.
- If the slider requires a non-flush inside mount, you must order a custom valance. Exact valance width and exact valance return length (minimum 1½") must be specified in the Special Instructions section of the order form.
- Custom returns are available for IB non-flush and OB Cellular Sliders. Please specify return length upon ordering.

Things to Consider

- Since most Ovations are sold in large sizes, the shade will have a large fabric stack. On an outside mount, you may want to order the shade a few inches wider so that the fabric stack can be clear of the window.
- **Minimum Ovation Stack:** Ovation's minimum fabric stack measures 6½" regardless of the ordered width. Minimum fabric stacking dimensions are determined by the slider's hardware, not ordered width.

Color Lux® Cellular Shade Hardware Options

SIMPLICITY MOTORIZED CELLULAR SHADES - NON-RECHARGEABLE

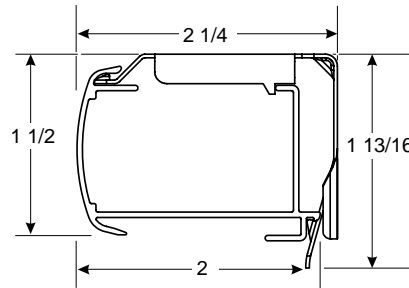

Simplicity Motorized Rail Dimensions

- Depth of rail: 2"
- Depth of rail and bracket: 2 1/4"
- Height of rail: 1 1/2"
- Height of bracket: 1 13/16"

Hardware Features	
Standard Hardware	<ul style="list-style-type: none"> • Fabric Wrapped head and bottom rails. Head rail and Bottom rails will have frosted end caps with fabric inserts. • Fabric used to cover the rails is the same fabric as the shade. The back of the rail will be white to the outside.
Simplicity Remote	Upper and lower limit stops pre-programmed, Intermediate stop "favorites" position can be set on site.
Upgrades	
Designer Metallic Upgrade	<ul style="list-style-type: none"> • Smooth faced Designer Oil Rubbed Bronze head, middle, bottom rails and end caps • Smooth faced Designer Brushed Nickel head, middle, bottom rails and end caps
Mounting Dimensions	
Simplicity Motorized Hardware System	
Minimum Shallow Mount	1/2"
Minimum Flush Inside Mount	2 1/4"
Minimum Outside Mount	7/8"
Minimum Side Mount	1 1/4"
Recommended Side Mounting Method	<ul style="list-style-type: none"> • See page 20 for recommended mounting method for side mount shades • Width limit for side mount brackets is 48"
Finished Dimensions	
Inside Mount	
	<ul style="list-style-type: none"> • Fabric will measure ordered width less: 3/8" • Head rail* will measure ordered width less: 3/16"
Outside Mount	
	<ul style="list-style-type: none"> • Fabric will measure ordered width • Head rail* will measure ordered width plus: 3/16"
Side Mount	
	<ul style="list-style-type: none"> • Fabric will measure ordered width less: 7/8" • Head rail* will measure ordered width less: 1 1/16"
Exact (End Cap to End Cap) Mount	
	<ul style="list-style-type: none"> • Fabric will measure ordered width less: 3/16" • Head rail* will measure ordered width
* Head rail measurements include endcaps. Width and length measurements may vary +/- 1/8"	

Color Lux® Cellular Shades SIMPLICITY MOTORIZED CELLULAR SHADES

Simplicity Motors

The Simplicity Motor program features a battery powered motor utilizing a single battery wand or plug-in DC transformer. Simplicity motors are compact and use a radio frequency remote to raise or lower the shades.

Motorized Lift Systems are not offered on sizes within the shaded area on the Standard Rectangular price grids.

- Length measurements may vary +/- 1/8".

Applications

- Standard Rectangular

EZ Level

Learn about the EZ Level feature on page 57.

Simplicity Motorization Surcharges

The standard Simplicity Motorized Lift System surcharge includes a 12 volt battery wand with eight AA batteries. Remotes are needed to operate the shades. See pricing pages.

Important Simplicity Motorized Shade Operating and Installation Information

- Simplicity Motorized Shades installed into windows with metal casings may have a reduced radio frequency range, or may not operate at all, depending on the application.
- Do not let the antenna on the motor touch any metal objects. This may interfere with signals from the remote control.

SIMPLICITY MOTORIZATION PRICING EXAMPLE:

Color Lux	
Light Filtering 42" x 60" Shade:	\$386.00
Simplicity Motor Surcharge:	\$334.00
Simplicity Remote Control:	\$40.00
Total List Price:	\$760.00

Simplicity Battery Wand

Batteries are needed to operate Simplicity motors. The battery wand can be clipped to the head rail or wall or ceiling mounted utilizing white battery wand clips. The 12 volt battery wand measures 17 1/4", and comes with eight AA alkaline batteries, and is white in color.

The battery wire is 10" long. A 48" extension wire is available.



Simplicity Motor Battery Life and Replacement

Eight alkaline batteries are included with the wand.

The battery life will vary based on the type of window covering selected, the size and weight of the window covering and the number of times you operate the shade on a daily basis. For example, a 36" x 60" single honeycomb shade operated twice daily will commonly have a battery life which lasts up to 18 months.

Comfortex will warranty batteries for up to 3 months from date of purchase.

Simplicity Hand Held Remotes

The 5 Channel remote can operate up to five shades individually or 5 groups. **WHEN ORDERING PLEASE SPECIFY WHICH CHANNELS ARE ASSIGNED TO EACH SHADE OR GROUP OF SHADES.** For example; program line 1 to channel 1, line 2 and 3 to channel 2, etc. If no channels are assigned at time of order, all shades will be programmed to Channel 1. **To reprogram channel assignments, please refer to the installation instructions and/or view the video at comfortex.com/comfortex-dealers.**



Simplicity remotes and holders are black or white in color. The remote comes with a holder which can be mounted to a wall for easy storage. The range of the remote is approximately 80 feet.

The Simplicity remote utilizes one 3V battery (CR2032). Batteries are included. Comfortex will warranty batteries for up to 3 months from date of purchase.

A **6 Channel (6C) timer remote** is also available. See page 31 for more information.

DC Power Supply/Transformer

12 Volt DC power supply/transformer is available and requires a standard power outlet to power the motor. The transformer is an alternative to a battery wand. Each transformer can power a single shading. The power supply must plug in to the motor. The DC power supply is white and comes with a 80" wire. The dimensions are 1 7/8" wide x 3 1/4" long x 1 1/4" deep



Color Lux® Cellular Shade Hardware Options

SIMPLICITY RECHARGEABLE MOTORIZED CELLULAR SHADES

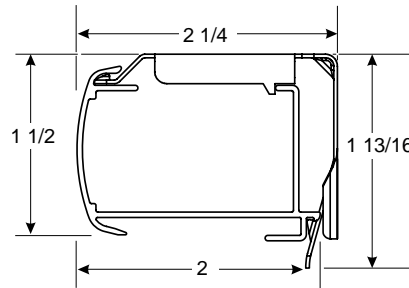

Simplicity Rechargeable Rail Dimensions

- Depth of rail: 2"
- Depth of rail and bracket: 2 1/4"
- Height of rail: 1 1/2"
- Height of bracket: 1 13/16"

Hardware Features	
Standard Hardware	<ul style="list-style-type: none"> Fabric Wrapped head and bottom rails. Head rail and Bottom rails will have frosted end caps with fabric inserts. Fabric used to cover the rails is the same fabric as the shade. The back of the rail will be white to the outside.
Simplicity Remote	Upper and lower limit stops pre-programmed, Intermediate stop "favorites" position can be set on site.
Upgrades	
Designer Metallic Upgrade	<ul style="list-style-type: none"> Smooth faced Designer Oil Rubbed Bronze head, middle, bottom rails and end caps Smooth faced Designer Brushed Nickel head, middle, bottom rails and end caps
Mounting Dimensions	
Simplicity Rechargeable Motorization Hardware System	
Minimum Shallow Mount	1/2"
Minimum Flush Inside Mount	2 1/4"
Minimum Outside Mount	7/8"
Minimum Side Mount	1 1/4"
Recommended Side Mounting Method	<ul style="list-style-type: none"> See page 20 for recommended mounting method for side mount shades Width limit for side mount brackets is 48"
Finished Dimensions	
Inside Mount	
	<ul style="list-style-type: none"> Fabric will measure ordered width less: 3/8" Head rail* will measure ordered width less: 3/16"
Outside Mount	
	<ul style="list-style-type: none"> Fabric will measure ordered width Head rail* will measure ordered width plus: 3/16"
Side Mount	
	<ul style="list-style-type: none"> Fabric will measure ordered width less: 7/8" Head rail* will measure ordered width less: 1 1/16"
Exact (End Cap to End Cap) Mount	
	<ul style="list-style-type: none"> Fabric will measure ordered width less: 3/16" Head rail* will measure ordered width
* Head rail measurements include endcaps. Width and length measurements may vary +/- 1/8"	

Color Lux® Cellular Shades

SIMPLICITY RECHARGEABLE MOTORIZED CELLULAR SHADES

Rechargeable Simplicity Motors

The Simplicity Motor program features a battery powered motor utilizing a rechargeable battery hidden inside the shade head rail. Simplicity motors are compact and use a radio frequency remote to raise or lower the shades.

Rechargeable Motorized Lift Systems are not offered on sizes within the shaded area on the Standard Rectangular price grids.

Applications

- Standard Rectangular

EZ Level

Learn about the EZ Level feature on page 57.

Rechargeable Simplicity Motorization Surcharges

The Rechargeable Simplicity Motorized Lift System surcharge includes a rechargeable battery. Remotes are needed to operate the shades. Refer to pricing pages.

Important Simplicity Motorized Shade Operating and Installation Information

- Simplicity Motorized Shades installed into windows with metal casings may have a reduced radio frequency range, or may not operate at all, depending on the application.
- Do not let the antenna on the motor touch any metal objects. This may interfere with signals from the remote control.

SIMPLICITY RECHARGEABLE BATTERY WAND PRICING EXAMPLE:

Linen Weave	
Light Filtering 42" x 60" Shade:	\$386.00
Simplicity Rechargeable Surcharge:	\$334.00
Charger for Rechargeable :	\$27.00
Simplicity Remote Control:	\$40.00
Total List Price:	\$787.00

Simplicity Rechargeable Battery

The rechargeable battery is concealed in the head rail of the shade. A charger is required for the rechargeable battery. The rechargeable battery comes fully charged from the factory.



Charging Port on Back of Head rail.

Retrofit Existing Standard Simplicity Motorized Shades with Rechargeable Batteries

Cellular shades made with Standard Simplicity Motorization can be retrofitted with the Rechargeable Simplicity Motorization Battery Wand. The Rechargeable battery wand is 22" long, comes with 10 NiMH batteries, and is white in color. Battery wands are charged at the factory.

To retrofit the rechargeable battery wand to an existing shade with a cassette head rail, you must have at least 24" between bracket centerlines to fit the battery wand. Otherwise, the wand must be placed elsewhere along the window. Wall mounting clips are provided with the wand.

Retrofit Ordering Requirements:

- Rechargeable battery wand with clips (one per shade)
- Rechargeable battery charger (one or more per order, or as needed)
- Charge port mounting base (optional)

Please contact customer service for more information.



Battery Wand for Rechargeable Simplicity Retrofit



Rechargeable Battery Wand Concealed in Head rail. (Minimum width of 30" required) otherwise battery wand must be mounted externally.

Color Lux® Cellular Shades

SIMPLICITY RECHARGEABLE MOTORIZED CELLULAR SHADES

Simplicity Rechargeable Battery Life

Rechargeable batteries are included with the motor.

The average battery charge will last 6-12 months based on an average sized shade raised and lowered once per day. The life of the battery charge will vary based on the type of window covering selected, the size and weight of the window covering and the number of times the shade is operated on a daily basis.

The battery can be recharged up to 500 times. It takes approximately 5 hours to recharge the motor when fully depleted.

Ordering Information for Rechargeable Motorized Cellular Shades

Simplicity Motor Option

- Specify IB or OB mount and rail color.
- Specify remote and other accessories if needed.
- Specify one or more battery chargers.

Please Note:

- Not all motors run at the same rate of speed.
- Simplicity motors have a "Favorites" or "MY" position setting. If the homeowner wants to set several shades at the same intermediate position, follow instructions provided with installation manual.
- Simplicity Rechargeable Motorized Cellular Shades are programmed at the factory with the "up and down" limits. The shades are **UNLINKED** from the remote so they are not able to operate during shipping. Each shade should be installed **before** linking it to the remote.
- **REMEMBER: Order at least one charger if ordering rechargeable motors.**

Simplicity Motorized Shade Warranty

Please see pages 112-114 for complete Comfortex warranty information.

Battery Charger

8.4 Volt charger requires a standard power outlet to recharge the battery wand. Must specify charger when ordering a Simplicity Rechargeable Wand Shade. The charger plugs into the charger port. The charger is black and comes with a 156" (13') wire. The dimensions are 1" wide x 2½" length x 1¾" deep.



Simplicity Motor Hand Held Remotes 5 Channel Remote

The **5 Channel (5C) remote** can operate up to five shades individually or 5 groups. Simplicity Rechargeable Motorized Cellular Shades are programmed at the factory with the "up and down" limits. The shades are **UNLINKED** from the remote so they are not able to operate during shipping. Each shade should be installed **after** linking it to the remote.

Simplicity 5C remotes and holders are white or black in color. The remote comes with a holder which can be mounted to a wall for easy storage. The range of the remote is approximately 80 feet.



6 Channel Timer Remote

The **6 Channel (6C) timer remote** combines the functionality of a six channel hand-held control with the convenience of a programmable timer.

- The 6C timer remote allows for 18 different scheduled actions.
- Manual function disables the timer and the remote then operates as a held remote.

Simplicity 6C remotes and holders are white in color. The remote comes with a holder which can be mounted to a wall for easy storage. The range of the remote is approximately 80 feet.



Simplicity Rechargeable Motorized Cellular Shades are programmed at the factory with the "up and down" limits. The shades are **UNLINKED** from the remote so they are not able to operate during shipping. Each shade should be installed **after** linking it to the remote.

Simplicity Motor Hand Held Remotes Operation

Press the up or down button on the remote to raise or lower the shade to your desired position.

To reprogram channel assignments, please refer to the installation instructions and/or view the video at: comfortex.com/comfortex-dealers.

The Simplicity remotes utilize one 3V battery. Batteries are included. Comfortex will warranty batteries for up to 3 months from date of purchase. Batteries are not covered by the warranty.

Color Lux® Cellular Shade Hardware Options
SIMPLICITY RECHARGEABLE MOTORIZED TOP DOWN-BOTTOM UP CELLULAR SHADES

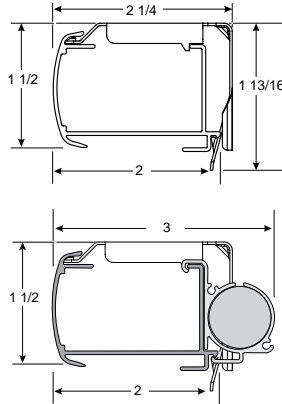

Simplicity Motorized Rail Dimensions

- Depth of rail: 2"
- Depth of rail and bracket: 2 1/4"
- Height of rail: 1 1/2"
- Height of bracket: 1 13/16"

Simplicity Motorized Rail with External Battery Dimensions

- Depth of rail: 2"
- Depth of rail, bracket & battery: 3"
- Height of rail: 1 1/2"
- Height of bracket: 1 13/16"

Hardware Features

Standard Hardware	<ul style="list-style-type: none"> • Fabric Wrapped head, middle and bottom rails. Head rail and Bottom rails will have frosted end caps with fabric inserts. • Fabric used to cover the rails is the same fabric as the shade. The back of the rail will be white to the outside.
TDBU 14 Channel Remote	Upper and lower limit stops pre-programmed.
Upgrades	
Designer Metallic Upgrade	<ul style="list-style-type: none"> • Smooth faced Designer Oil Rubbed Bronze head, middle, bottom rails and end caps • Smooth faced Designer Brushed Nickel head, middle, bottom rails and end caps

Mounting Dimensions

Mounting Dimensions	Simplicity Motorized Hardware System
Minimum Shallow Mount	1/2"
Minimum Flush Inside Mount	2 1/4"
Minimum Outside Mount	7/8"
Minimum Side Mount	1 1/4"

Recommended Side Mounting Method

- See page 47 for recommended mounting method for side mount shades
- Width limit for side mount brackets is 48"

Finished Dimensions

Inside Mount

- Fabric will measure ordered width less: 3/8"
- Head rail* will measure ordered width less: 3/16"

Outside Mount

- Fabric will measure ordered width
- Head rail* will measure ordered width plus: 3/16"

Side Mount

- Fabric will measure ordered width less: 7/8"
- Head rail* will measure ordered width less: 1 1/16"

Exact (End Cap to End Cap) Mount

- Fabric will measure ordered width less: 3/16"
- Head rail* will measure ordered width

* Head rail measurements include endcaps. Width and length measurements may vary +/- 1/8"

Color Lux® Cellular Shades

SIMPLICITY RECHARGEABLE TOP DOWN-BOTTOM UP MOTORIZED SHADES

Rechargeable Simplicity Motors

The Simplicity Motor program features a battery powered motor utilizing a rechargeable battery hidden inside the shade head rail. If shades are less than 36" in width, an external snap-on battery pack is necessary. (See picture to right)

Applications

- Rectangular

EZ Level

Learn about the EZ Level feature on page 57.

Rechargeable Simplicity Motorization Surcharges

The Rechargeable Simplicity Motorized Lift System surcharge includes a rechargeable battery. Remotes are needed to operate the shades. Refer to pricing pages.

Ordering Information for Top Down-Bottom Up Motorized Cellular Shades

Simplicity Motor Option

- Specify IB or OB mount and rail color.
- 14 Channel TDBU Remote is required.
- Specify one or more battery chargers.

Please Note:

- Shades that are 24"-36" in width will have an external battery.
- Shades with an external battery and OB mounted will need spacer blocks.
- Simplicity Rechargeable Motorized Cellular Shades are programmed at the factory with the "up and down" limits set on both moving rails.
- **REMEMBER: Order at least one charger if ordering rechargeable motors.**

Top Down-Bottom Up Simplicity Motor Hand Held 14 Channel Remote

The TDBU remote has 14-channels. Each channel has a setting to operate the middle rail and a setting to operate the bottom rail. The TDBU remote is required for TDBU motors. The **14 Channel TDBU remote** can operate up to fourteen shades individually or 14 groups. Simplicity Rechargeable Motorized Cellular Shades are programmed at the factory with the "up and down" limits. The shades are **UNLINKED** from the remote so they are not able to operate during shipping. Each shade should be installed **after** linking it to the remote.



Simplicity TDBU remotes and holders are white in color. The remote comes with a holder which can be mounted to a wall for easy storage. The range of the remote is approximately 80 feet.

Simplicity Rechargeable Battery

The rechargeable battery is concealed in the head rail of the shade. A charger is required for the rechargeable battery. The rechargeable battery comes fully charged from the factory.

Rechargeable Battery Pack is concealed in the head rail. Minimum width of 36" is required otherwise battery wand must be mounted externally.



Charging Port on Back of Head rail.



Snap-On external battery for shades under 36" in width. Spacer block also shown, required for outside mount.

Battery Charger

8.4 Volt charger requires a standard power outlet to recharge the battery wand. Must specify charger when ordering a Simplicity Rechargeable Wand Shade. The charger plugs into the charger port. The charger is black and comes with a 156" (13') wire. The dimensions are 1" wide x 2½" length x 1¾" deep.



MOTORIZED TOP DOWN-BOTTOM UP PRICING EXAMPLE:

Linen Weave	
Light Filtering 42" x 60" Shade:	\$386.00
Simplicity Rechargeable Surcharge:	\$535.00
Charger for Rechargeable:	\$27.00
TDBU Remote Control:	\$65.00
Total List Price:	\$1013.00

Color Lux® Cellular Shade Hardware Options SIMPLICITY SMART CONTROLLER

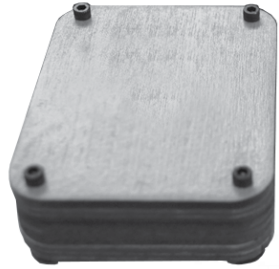

Simplicity Smart Controller Dimensions

- Width of controller: 2³/₈"
- Length of controller: 2¹⁵/₁₆"
- Height of controller: 1¹/₈"

Simplicity Smart Controller

- Works with Apple and Android devices
- FREE Downloadable Application
- Compatible with previously installed Simplicity Remote Control Shades
- Powered by NEO Smart Blinds App

Simplicity Smart Controller

The Simplicity Smart Controller is a small device that you install in your home that allows you to set automatic opening and closing times for all Simplicity motorized shades as well as the ability to control your motorized shades from a phone, tablet or PC from anywhere in world.

The Simplicity Smart Controller will work with any Comfortex remote motorized shade with Simplicity remote control motors purchased after 2012.

The Simplicity Smart Controller plugs into a standard electrical outlet and connects to WiFi and sends signals to your shades using the same radio frequencies as a normal remote control.

How Does The NEO Smart Blinds App Work?

The app uses WiFi or cellular data to send commands over the internet to the Simplicity Smart Controller.

Do I Need Any Other Equipment?

Yes, The location where your shades are installed must have WiFi in order for the Simplicity Smart Controller to work. Additionally, you must have a smartphone or tablet running Android or iOS (eg. iPhone, iPad, Samsung Galaxy S7) and have the NEO Smart Blinds app. installed.

Why Would I Want A Simplicity Smart Controller?

There are two main ways the Simplicity Smart Controller adds additional value to your motorized shades. First, once all of your shades have been added, you can use your smartphone as a single remote for all of your shades that will work anywhere you are regardless of distance from the shade. Secondly, the device allows you to set schedules so your motorized shades automatically open and close without needing to do anything on a day to day basis.

Do I Need To Buy More Than 1 Controller?

The normal use for the Simplicity Smart Controller is to plug it in out of the way and forget it. Since it has roughly the same range as a remote you will want enough devices to allow all shades to be operated without moving the controller. So depending on the layout of the home and location of the shade, you might want multiple devices to have convenient full home coverage.

How Far Is The Range Of A Controller?

You should see a range of approximately 150 ft. However this number might be less depending on the layout of your home. In general we recommend one per a floor of a normal sized home.

Can I Control My Shades From Multiple Devices?

Yes! You can download the NEO Smart Blinds App onto multiple devices, After installing the App. on a new device simply log in with the same email/password on each device and you will have access to control your shades.

Can It Be Used With Already Installed Shades?

Yes! Simply follow the directions in the NEO Smart Blinds app. to add a shade. At the pairing step you can put the shade in pairing mode using the primary remote control for it (or by accessing the button on the shades motor). Adding the shade to the NEO Smart Blinds App. will not affect the normal remote operation.

How Much Does The NEO Smart Blinds App Cost?

The app is a free download, However you must have at least one Simplicity Smart Controller (\$330) to serve as a bridge between the app and your shades.

Color Lux® Cellular Shades
POWERTOUCH RECHARGEABLE MOTORIZED SHADES

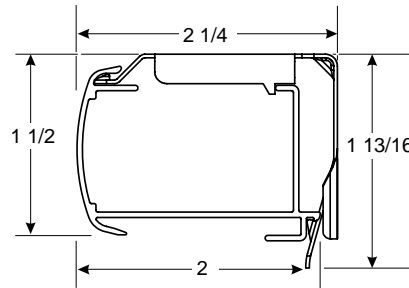

Simplicity Motorized Rail Dimensions

- Depth of rail: 2"
- Depth of rail and bracket: 2 1/4"
- Height of rail: 1 1/2"
- Height of bracket: 1 13/16"

Hardware Features	
Standard Hardware	<ul style="list-style-type: none"> • Fabric Wrapped head and bottom rails. Head rail and Bottom rails will have frosted end caps with fabric inserts. • Fabric used to cover the rails is the same fabric as the shade. The back of the rail will be white to the outside.
Simplicity Remote	Upper and lower limit stops pre-programmed, Intermediate stop "favorites" position can be set on site.
Upgrades	
Designer Metallic Upgrade	<ul style="list-style-type: none"> • Smooth faced Designer Oil Rubbed Bronze head, middle, bottom rails and end caps • Smooth faced Designer Brushed Nickel head, middle, bottom rails and end caps
Mounting Dimensions	
Simplicity Motorized Hardware System	
Minimum Shallow Mount	1/2"
Minimum Flush Inside Mount	2 1/4"
Minimum Outside Mount	7/8"
Minimum Side Mount	1 1/4"
Recommended Side Mounting Method	<ul style="list-style-type: none"> • See page 20 for recommended mounting method for side mount shades • Width limit for side mount brackets is 48"
Finished Dimensions	
Inside Mount	
	<ul style="list-style-type: none"> • Fabric will measure ordered width less: 3/8" • Head rail* will measure ordered width less: 3/16"
Outside Mount	
	<ul style="list-style-type: none"> • Fabric will measure ordered width • Head rail* will measure ordered width plus: 3/16"
Side Mount	
	<ul style="list-style-type: none"> • Fabric will measure ordered width less: 7/8" • Head rail* will measure ordered width less: 1 1/16"
Exact (End Cap to End Cap) Mount	
	<ul style="list-style-type: none"> • Fabric will measure ordered width less: 3/16" • Head rail* will measure ordered width
* Head rail measurements include endcaps. Width and length measurements may vary +/- 1/8"	

Color Lux® Cellular Shades

POWERTOUCH RECHARGEABLE MOTORIZED SHADES

PowerTouch™ Rechargeable Shades

Cellular Shades can be fabricated with the PowerTouch Rechargeable Push Button Control option. The PowerTouch Rechargeable option is an easy, cord free motorized operation for the budget savvy homeowner. PowerTouch Rechargeable uses Simplicity motors and components.

PowerTouch Rechargeable Shades Operation

Press the up or down button on the pendant to raise or lower the shading to your desired position. When the shading is fully lowered to the factory programmed lower limit.

No programming is required with PowerTouch™, all programming is set at the factory. Upper and lower limits easily can be adjusted in the field if desired. Please refer to the installation instructions at comfortex.com/ comfortex-dealers.com/. A "favorites" or intermediate stop position can be set once installed.

PowerTouch Rechargeable Surcharges

See page 3.

PowerTouch Appearance

- The PowerTouch wand and pendant is attached to the head rail when installed.
- The wand and pendant hangs down the front of the shades from the head rail. The wand does not touch the fabric.
- Pendant is 2½" long.
- The pendant does not need to be mounted to the wall to operate the shade.



PowerTouch Rechargeable Color Options

- Shades with Black or Oil Rubbed Bronze hardware will be built with black wand and pendants standard. All other colors will use white wand and pendants.



White



Black Shown with Plug-In Charger

PowerTouch Wand and Pendant Location

The standard location for the wand and pendant is on the right. Please specify location when ordering.

PowerTouch Rechargeable Wand Length

- The standard length of the wand will measure the indicated below unless otherwise specified.

Shading Length	Standard Wand Length
Up to 30"	1' (12")
>30" to 52"	2' (24")
>52" to 78"	3' (36")
>78" to 100"	4' (48")
>100" to 120"	5' (60")

Mounting Requirements for PowerTouch Rechargeable Shades

- No special installation hardware or wiring requirements are needed.

Battery Charger

8.4 Volt charger requires a standard power outlet to recharge the battery wand. Must specify charger when ordering a Simplicity Rechargeable Wand Shade. The charger plugs into the charger port. The charger is black and comes with a 156" (13') wire. The dimensions are 1" wide x 2½" length x 1¾" deep.



PowerTouch Rechargeable Shades Warranty

Please see page 112 for complete warranty information.

Color Lux® Cellular Shade Hardware Options

SIMPLICITY WAVE RECHARGEABLE MOTORIZED CELLULAR SHADES

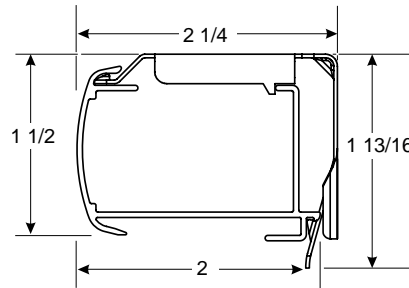

Simplicity Rechargeable Rail Dimensions

- Depth of rail: 2"
- Depth of rail and bracket: 2 1/4"
- Height of rail: 1 13/16"
- Height of bracket: 1 1/2"

Hardware Features	
Standard Hardware	<ul style="list-style-type: none"> • Fabric Wrapped head and bottom rails. Head rail and Bottom rails will have frosted end caps with fabric inserts. • Fabric used to cover the rails is the same fabric as the shade. The back of the rail will be white to the outside.
Telescoping Wand	Extends to 33" to reach shades mounted high. Wand retracts to 9" for easy storage.
Mounting Dimensions	
Simplicity Wave Rechargeable Motorization Hardware System	
Minimum Shallow Mount	1/2"
Minimum Flush Inside Mount	2 1/4"
Minimum Outside Mount	7/8"
Minimum Side Mount	1 1/4"
Recommended Side Mounting Method	<ul style="list-style-type: none"> • See page 20 for recommended mounting method for side mount shades • Width limit for side mount brackets is 48"
Finished Dimensions	
Inside Mount	
	<ul style="list-style-type: none"> • Fabric will measure ordered width less: 3/8" • Head rail* will measure ordered width less: 3/16"
Outside Mount	
	<ul style="list-style-type: none"> • Fabric will measure ordered width • Head rail* will measure ordered width plus: 3/16"
Side Mount	
	<ul style="list-style-type: none"> • Fabric will measure ordered width less: 7/8" • Head rail* will measure ordered width less: 1 1/16"
Exact (End Cap to End Cap) Mount	
	<ul style="list-style-type: none"> • Fabric will measure ordered width less: 3/16" • Head rail* will measure ordered width
* Head rail measurements include endcaps. Width and length measurements may vary +/- 1/8"	

Color Lux® Cellular Shades SIMPLICITY WAVE MOTORIZED CELLULAR SHADES

Wave Rechargeable Simplicity Motor

The Simplicity Wave Motor features a battery powered motor utilizing a rechargeable battery hidden inside the shade head rail. Simplicity wave motors are compact and use a telescoping wand to raise or lower the shades.

Wave Rechargeable Motorized Lift Systems are not offered on sizes within the shaded area on the Standard Rectangular price grids.

Applications

- Rectangular

EZ Level

Learn about the EZ Level feature on page 57.

Simplicity Wave Rechargeable Motorization Surcharges

The Simplicity Wave Rechargeable Motorized Lift System surcharge includes a rechargeable battery. A Wand is needed to operate the shades and a charger to charge the battery. Refer to pricing pages.

Ordering Information for Rechargeable Motorized Cellular Shades

Simplicity Motor Option

- Specify IB or OB mount and rail color.
- Specify wand and other accessories if needed.
- Specify one or more battery chargers.

Please Note:

- Not all motors run at the same rate of speed.
- Simplicity Wave Rechargeable Motorized Cellular Shades are programmed at the factory with the "up and down" limits.
- **REMEMBER: Order at least one charger if ordering rechargeable motors.**

SIMPLICITY RECHARGEABLE BATTERY WAND PRICING EXAMPLE:

Linen Weave	
Light Filtering 42" x 60" Shade:	\$350.00
Simplicity Wave Surcharge:	\$110.00
Charger for Wave Rechargeable:	\$27.00
Simplicity Wave Wand:	\$29.00
Total List Price:	\$751.00

Simplicity Wave Rechargeable Battery

The rechargeable battery is concealed in the head rail of the shade. A charger is required for the rechargeable battery. The rechargeable battery comes fully charged from the factory.



Charging Port on Back of Head rail.

Simplicity Rechargeable Battery Life

Rechargeable batteries are included with the motor.

The average battery charge will last 6-12 months based on an average sized shade raised and lowered once per day. The life of the battery charge will vary based on the type of window covering selected, the size and weight of the window covering and the number of times the shade is operated on a daily basis.

The battery can be recharged up to 500 times. It takes approximately 5 hours to recharge the motor when fully depleted.

Battery Charger

8.4 Volt charger requires a standard power outlet to recharge the battery pack. Must specify charger when ordering a Simplicity Rechargeable Wand Shade. The charger plugs into the charger port. The charger is black and comes with a 156" (13') wire. The dimensions are 1" wide x 2½" length x 1¾" deep.



Telescoping Wand

- Extends to 33" to reach shades mounted high.
- Wand retracts to 9" for easy storage.
- The wand is silver with white handle and white magic tip.
- Wall mount plate included for convenience.
- Wand is universal and will operate all Simplicity Wave shades

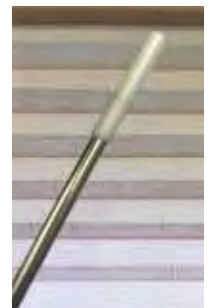

Simplicity Motorized Shade Warranty

Please see pages 112-114 for complete Comfortex warranty information.

The Ultimate Blackout Cellular Shade Head Rail Options

INSULATING SLUMBERSHADES

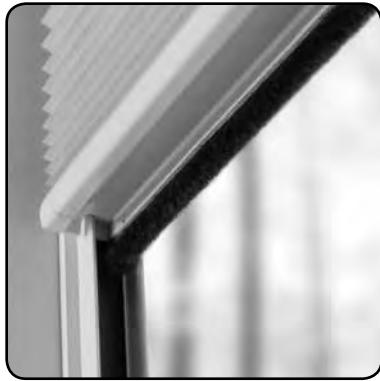

Deluxe Head Rail

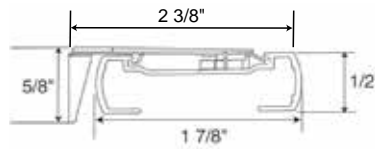

Cord Loop & Cordless Ultra Head Rail (Standard & Top Down-Bottom Up)

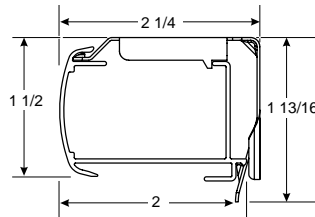

Deluxe Cord Lock Rail

- Depth of rail: 1 7/8"
- Depth of rail and bracket: 2 3/8"
- Height: 1/2"
- Height of bracket: 5/8"

Cord Loop & Cordless Ultra Rail

- Depth of rail: 2"
- Depth of rail and bracket: 2 1/4"
- Height of rail: 1 1/2"
- Height of bracket: 1 13/16"

Hardware Features	
Hardware colors for all Cellular fabrics	Fabric wrapped head, middle, bottom rails and end caps is standard. Back of rail is white to outside.
Blackout Sidetrack Colors Available	White, Tan and Bronze
Upgrades	
Designer Metallic Upgrade	• Oil Rubbed Bronze and Brushed Nickel head, middle, bottom rails and end caps.
Mounting Dimensions (inside mount only)	
Deluxe Head Rail	
Standard Cord Lock (Standard Retangular and Top Down-Bottom Up)	
Minimum Inside Mount	1 1/2"
Minimum Flush Inside Mount	2 3/8"
Cord Loop & Cordless Ultra (Standard Retangular and Top Down-Bottom Up)	
Minimum Inside Mount	NA
Minimum Flush Inside Mount	NA
Outside, shallow and side mounts are not available. The shade's light blocking ability is compromised by using any other mount than a fully flush mount application.	
Finished Dimensions	
Inside Mount	
	<ul style="list-style-type: none"> • Fabric will measure ordered width less: 7/8" • Head rail and bottom rail will measure ordered width less: 1 1/16" • Sidetrack length will measure ordered length less: 1/8"

The widest width of the window cannot exceed the narrowest width of the window by more than 1/4".

Precise width measurements are critical to proper performance of SlumberShade products. Make sure to measure to the nearest 1/16" and provide the NARROWEST width measurement along the length of the window. Be sure to measure the top, middle and bottom of the opening. It is very common for the width of a window to vary from top to bottom.

The Ultimate Blackout Cellular Shade Head Rail Options

INSULATING SLUMBERSHADE SHADES

Applications

- Standard Rectangular • Top Down - Bottom Up
- Cordless and Cordless Top Down - Bottom Up
- Cord Loop and Top Down - Bottom Up

SlumberShades are for inside mount applications only.

Insulating SlumberShade Fabric

Light Filtering fabrics are available as SlumberShades, however the best light control is achieved by using a blackout cellular fabric. Not available in Boutique fabric.

Ordering Information for Insulating SlumberShades

SlumberShades are for inside mount applications only.

Precise width measurements are critical to proper performance of SlumberShade products. Make sure to measure to the nearest 1/16" and provide the **NARROWEST** width measurement along the length of the window. Be sure to measure the top, middle and bottom of the opening. It is very common for the width of a window to vary from top to bottom. The widest width of the window cannot exceed the narrowest width of the window by more than 1/4". If you have questions about ordering SlumberShades, contact Comfortex Technical Services at 800-843-4151.

Accessories

- 6' Expandable Pole: \$37.00
- 12' Expandable Pole: \$46.00

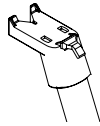

Specially designed pole end fits into the handle on the Cordless Ultra bottom rail and allows for easy operation.

Insulating SlumberShades Features

Use SlumberShades to provide the darkest sleeping environment by sealing out the highest percentage of light.

Energy Saving Blackout Sidetracks

Energy saving blackout sidetracks are made from a durable window grade PVC. The blackout sidetracks seal off the light gap between the blackout cellular shade and the window. The blackout sidetracks feature a black interior lining to absorb light and prevent it from entering the room.



Insulating SlumberShades Large Track Dimensions

Used with all fabrics that utilize the deluxe sized head rail.

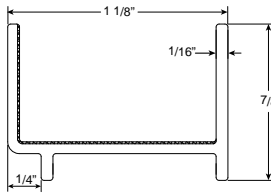

Large Track

- Width of track: 1 1/8"
- Height of track: 7/8"

SlumberShades are easy to install, and feature removable sidetracks that are attached to the window frame with magnets. The sidetracks can be removed for window cleaning. The UV stable, window grade PVC sidetracks are available in white, tan and bronze to match your existing trim.

Please Note: When properly installed, SlumberShades block 99% of all visible light. In certain installations with intense sunlight, a very small amount of light may reflect around the edges of the honeycomb fabric along each side of the shade. This is a normal attribute of the SlumberShade system.

Insulating SlumberShade End Caps

The specially designed notched bottom rail end caps fit over the blackout sidetracks and allow for smooth movement when raising and lowering the shade.

Head and Bottom Rail Seals

To ensure a perfectly dark sleeping environment, additional fuzzy seals are supplied to be placed along the shade's bottom rail and between the head rail and the window frame if needed. These barriers provide a complete light stop all the way around the window to keep all exterior light out. Also, these additional seals provide a very effective barrier against heat loss along your windows.

Magnets and fuzzy bar are standard on Cordless and Cordless Top Down-Bottom Up Shades to ensure closure between the bottom rail and window sill.

Energy Efficiency

Independent testing has shown SlumberShades provide an R-value greater than 7.0* when installed over a double paned vinyl window. The testing also indicates that the R-value of a SlumberShade is 2.5 to 3 times higher than that of the same shade without sidetracks. The insulating cellular fabric, sidetracks, and fuzzy seal all ensure that the SlumberShades provides superior energy efficiency.

* Independent testing provided by Consortium for Advanced Residential Buildings (CARB), a U.S. Department of Energy Building America research team. Learn more at comfortex.com.

EZ Level

Learn about the EZ Level feature on page 57.

Color Lux® Cellular Shades
STRATAVIEW™ CELLULAR SHADE

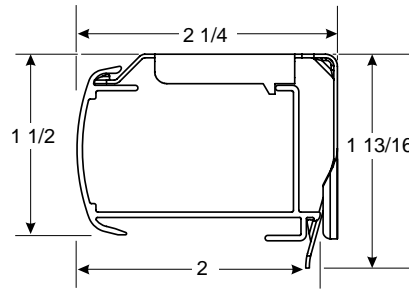

Cord Loop, Cordless Ultra & Simplicity Rechargeable Rail Dimensions

- Depth of rail: 2"
- Depth of rail and bracket: 2 1/4"
- Height of rail: 1 1/2"
- Height of bracket: 1 13/16"

A sheer top fabric panel and your choice of Color Lux fabric as the bottom panel.

Hardware Features	
Fabric Wrapped	Fabric wrapped head rail to match color of top sheer, middle and bottom fabric wrapped rails will match bottom fabric selection. Back of rail is white to outside. Frosted clear with fabric insert end caps. Clutch cover and Cordloop is white on cordloop shades.
Designer Metallic	<ul style="list-style-type: none"> • Oil Rubbed Bronze head and bottom rails with bronze end caps and white cord. • Brushed Nickel head and bottom rails and end caps with white cord.
Mounting Dimensions	
Minimum Shallow Mount	1/2"
Minimum Flush Inside Mount	2 1/4"
Minimum Outside Mount	7/8"
Minimum Side Mount	1 1/4"
Recommended Side Mounting Method	<ul style="list-style-type: none"> • See figure A, page 20 for recommended mounting method for side mount shades • Width limit for side mount brackets is 48"
Finished Dimensions	
Inside Mount	
	<ul style="list-style-type: none"> • Fabric will measure ordered width less: 3/8" • Head rail* will measure ordered width less: 3/16"
Outside Mount	
	<ul style="list-style-type: none"> • Fabric will measure ordered width • Head rail* will measure ordered width plus: 3/16"
Side Mount	
	<ul style="list-style-type: none"> • Fabric will measure ordered width less: 7/8" • Head rail* will measure ordered width less: 1 1/16"
Exact (End Cap to End Cap) Mount	
	<ul style="list-style-type: none"> • Fabric will measure ordered width less: 3/16" • Head rail* will measure ordered width
* Head rail measurements include endcaps. Width and length measurements may vary +/- 1/8"	



Top Panel and Bottom Panel

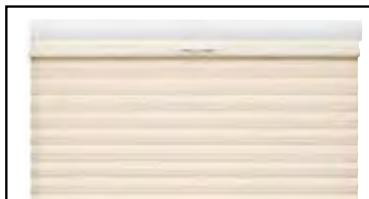

Bottom Panel Raised



Top Panel Lowered

Color Lux® Cellular Shades STRATAVIEW™ CELLULAR SHADE

StrataView™

StrataView is a dual panel shade featuring a sheer top fabric panel and your choice of Color Lux fabric as the bottom panel.

Hardware Options

- Cord Loop
- Cordless Ultra
- TDBU Simplicity Rechargeable Motorization

Cord Loop Hardware System

See page 19 for details.

Cordless Ultra Hardware System

See page 21 for details.

Simplicity Rechargeable Motorized Hardware System

See page 29 for details.

Recommended Mounting Method for Side Mounting Shades

See Page 20.

EZ Level on Cellular Shades

EZ Level makes quick work of leveling without cords to cut or tuck into a rail. Middle rail can not be adjusted in the field. See page 57 for details.

StrataView Fabric Specifications

Sheer fabric is always on the top of the shade. See fabric samples of the 3 sheer fabrics for the top of the StrataView in the Color Lux Sample Book.

BOTTOM FABRICS

CELLULAR	Width		Length	
	Min	Max	Min	Max
Cordless	18" OB 18 ³ / ₈ " IB	96"	8"	84"
Cordloop	22"	108"	8"	120"
Motorized	24" OB 24 ³ / ₈ " IB	108"	8"	120"

MOTORIZED STRATAVIEW TOP DOWN-BOTTOM UP PRICING EXAMPLE:

Linen Weave	
Light Filtering 42" x 60" Shade:	\$386.00
Simplicity Rechargeable Surcharge:	\$714.00
Charger for Rechargeable:	\$27.00
TDBU Remote Control:	\$65.00
Total List Price:	\$1192.00

Ordering Information for StrataView Shades

Cord Loop StrataView

- Specify IB or OB mount and rail color. Middle rail will match the top and bottom rails.
- Specify cord loop length when ordering.
- Controls are the right cord loop operates the middle rail and left cord loop operates the bottom. Reverse controls are not available.

Cordless Ultra StrataView

- Specify IB or OB mount and rail color. Middle rail will match the bottom rail

Accessories

- 6' Expandable Pole: \$37.00
- 12' Expandable Pole: \$46.00

Specially designed pole end fits into the handle on the Cordless Ultra bottom rails and allows for easy operation.

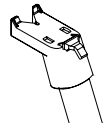

Simplicity Rechargeable StrataView

- Specify IB or OB mount and rail color. Middle rail will match the bottom rail.
- Specify remote and other accessories if needed.
- Specify one or more battery chargers.

StrataView Simplicity Motor Hand Held Remote 14 Channel Remote

The TDBU remote has 14-channels. Each channel has a setting to operate the middle rail and a setting to operate the bottom rail. The TDBU remote is required for StrataView motors. The **14 Channel TDBU remote** can operate up to fourteen shades individually or 14 groups. Simplicity Rechargeable Motorized Cellular Shades are programmed at the factory with the "up and down" limits. The shades are **UNLINKED** from the remote so they are not able to operate during shipping. Each shade should be installed **after** linking it to the remote.



Simplicity TDBU remotes and holders are white in color. The remote comes with a holder which can be mounted to a wall for easy storage. The range of the remote is approximately 80 feet.

REMEMBER: Order at least one charger if ordering rechargeable motor

Recommended Mounting Method for Side Mounting Shades

See Page 20.

Color Lux® Cellular Specialty Shades STARBURST ARCHES

Stationary Starburst

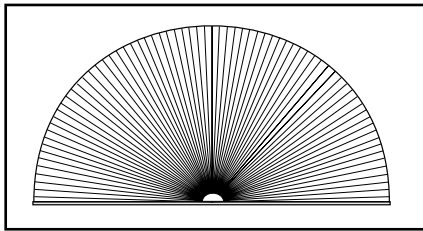

Figure A

Movable Starburst

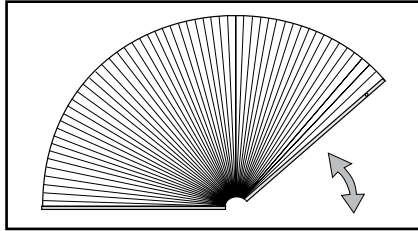

Figure B

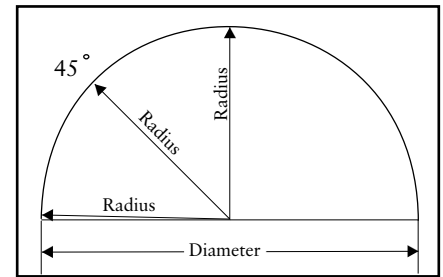

Figure C

Hardware Features | See Page 17 for Rail Dimensions

Standard Hardware	Fabric wrapped rail is standard. The fabric will be spliced in the center of the rail. A decorative rosette is supplied to conceal the splice.
Designer Metallic	<ul style="list-style-type: none"> • Oil Rubbed Bronze rails with bronze colored end caps. • Brushed Nickel rails and end caps.

Mounting Dimensions

Mounting Dimensions	Standard Cord Lock Rail
Minimum Shallow Mount	3/4"
Minimum Flush Inside Mount	2 3/8"
Recommended Side Mounting Method	<ul style="list-style-type: none"> • See figure B, pg 20 for recommended mounting method for side mount shades • Width limit for side mount brackets is 48"

Finished Dimensions

Inside and Side Mount

<ul style="list-style-type: none"> • Fabric will measure ordered width less: 3/8" • Head rail* will measure ordered width less: 3/16" 	<ul style="list-style-type: none"> * Head rail measurements include endcaps. Width and length measurements may vary +/- 1/8"
---	--

Applications

- Stationary Fan Style Arch
 - Movable Fan Style Arch
- Movable Starburst Arch shades are for inside and shallow mount applications only.

Stationary Starburst Features (Figure A)

- **All non-perfect Stationary Starburst arches require a template made from brown craft paper.** Comfortex offers template kits. Please contact Customer Service to order. Stock number: 751000, See page 111
- A perfect arch is twice as wide as it is high.
- Stationary Starburst shades which are not perfect half circles must have a height that equals half the width +/- 5".
- Price according to the largest radius measurement. If the height is greater than the width, take height X 2 and use that number to determine pricing.
- When ordering arches as perfect half-circles make sure the radius of the arch remains constant to ensure a proper fit. (See Figure C)

Movable Starburst Features (Figure B)

- Starburst Movable archtop shades are cut to perfect half circles only and do not require a template. The height must be exactly 1/2 the diameter.
- A perfect arch is twice as wide as it is high.
- When ordering arches as perfect half circles make sure the radius of the arch remains constant to ensure a proper fit. (See Figure C)
- The hinge gap (gap between the two rails) is not centered in the window. The moving rail is always smaller than the stationary rail to provide proper movement within the window.

Accessories

- 6' Expandable Pole: \$37.00
- 12' Expandable Pole: \$46.00

Specially designed pole end fits into the handle on movable Starburst Shades for easy operation.



Color Lux® Cellular Specialty Shades

QUARTER ROUNDS

Movable Quarter Round

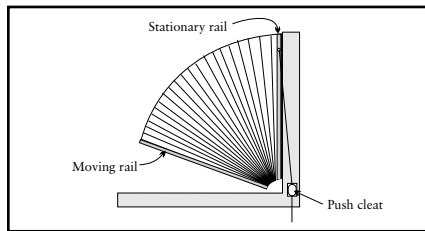

Figure A

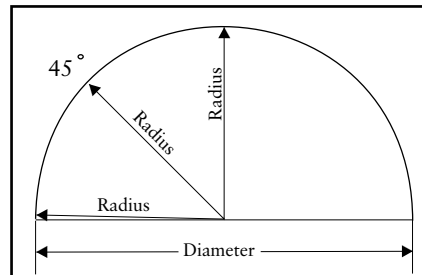

Figure B

Stationary Quarter Round

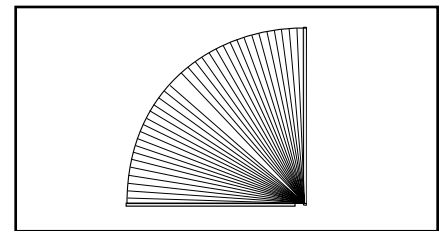

Figure C

Hardware Features | See Page 17 for Rail Dimensions

Hardware colors for all Cellular and Pleated fabrics	Fabric wrapped rails with white cord and tassel. Fabric used is same fabric as the shade. Back of rail is white to outside.
--	---

Upgrades

Designer Metallic Upgrade	<ul style="list-style-type: none"> • Oil Rubbed Bronze rails and endcaps, bronze colored tassel and white cord. • Brushed Nickel rails and end caps with coordinating tassel and white cord.
---------------------------	--

Mounting Dimensions

	Standard Rail	Deluxe Rail
Minimum Shallow Mount	3/4"	3/4"
Minimum Flush Inside Mount	2"	2 3/8"
Minimum Outside Mount	3/4"	3/4"
Minimum Side Mount	1 1/8"	1 3/8"
Recommended Side Mounting Method	• See page 20 figure F for recommended mounting method for side mount shades	

Finished Dimensions

Inside and Side Mount

- Fabric will measure ordered width less: 3/8"
- Head rail* will measure ordered width less: 3/16"

Outside Mount

- Fabric will measure ordered width
- Head rail* will measure ordered width plus: 3/16"

Exact (End Cap to End Cap) Mount

- Fabric will measure ordered width less: 3/16"
- Head rail* will measure ordered width

* Head rail measurements include endcaps.
Width and length measurements may vary +/- 1/8"

Applications

- Stationary Fan Style Quarter Round
- Movable Fan Style Quarter Round

Accessories

- 6' Expandable Pole: \$37.00
- 12' Expandable Pole: \$46.00



Ordering Information for Quarter Rounds Shades

- Specify IB or OB mount and rail color.
- Include a template if the shade is a non-perfect quarter round.

Specially designed pole end fits into the handle on movable Quarter Round Shades for easy operation.

Color Lux® Cellular Specialty Shades QUARTER ROUNDS

Quarter Rounds Features (Figure A)

- **All Quarter Round Shades which are not perfect quarter circles require a template.** Price according to the largest radius measurement.
- See page 111 for template instructions.
- **All templates should be made from brown craft paper.** Comfortex offers template kits. Please contact Customer Service to order. Stock number: 751000
- The horizontal (moving) rail of a Movable Quarter Round shade **must be smaller** than the vertical (stationary) rail to allow clearance for the moving rail. The shade will stack in the vertical position.
- When ordering arches as perfect quarter circles, make sure the radius of the arch remains constant to ensure a proper fit. (See Figure B, page 44)



Color Lux® Cellular Specialty Shades
SUNSET ARCHES

COLOR LUX® CELLULAR SHADES

Movable Sunset

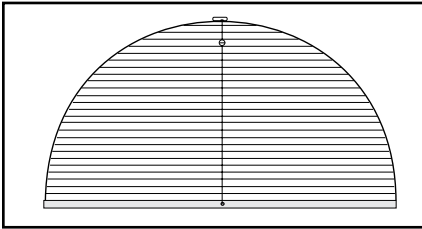

Figure A

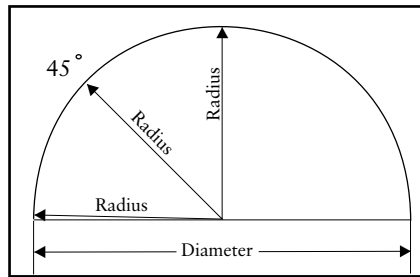

Figure B

Two-String Hanging Method

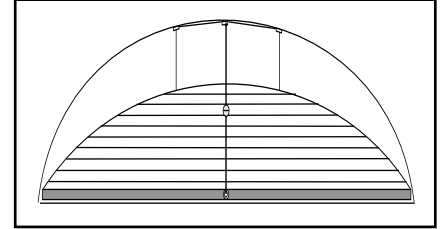

Figure C

Hardware Features | See Page 17 for Rail Dimensions

Fabric Wrapped	Fabric used is same fabric as the shade. Back of rail is white to outside. Clear frosted end caps, white cord and silver tassel
Designer Metallic	<ul style="list-style-type: none"> • Oil Rubbed Bronze rails with bronze colored end caps and white cord. • Brushed Nickel rails and end caps with white cord.

Mounting Dimensions	Standard Cord Lock Rail
Minimum Shallow Mount	3/4"
Minimum Flush Inside Mount	2 3/8"
Minimum Outside Mount	3/4" Outside mounting requires the use of an extension "L" bracket for the mounting of the top block.
Minimum Side Mount	1 1/8"
Recommended Side Mounting Method	<ul style="list-style-type: none"> • See page 20, figure A for recommended mounting method for side mount shades • Width limit for side mount brackets is 48"

Finished Dimensions

Inside and Side Mount	
	<ul style="list-style-type: none"> • Fabric will measure ordered width less: 3/8" • Head rail* will measure ordered width less: 3/16"
Outside Mount	
	<ul style="list-style-type: none"> • Fabric will measure ordered width • Head rail* will measure ordered width plus: 3/16"
Exact (End Cap to End Cap) Mount	
	<ul style="list-style-type: none"> • Fabric will measure ordered width less: 3/16" • Head rail* will measure ordered width

* Head rail measurements include endcaps.
Width and length measurements may vary +/- 1/8"

Applications

- Movable Arch

Ordering Information for Sunset Shades

- Specify IB or OB mount and rail color.
- Include a template if the shade is a non-perfect arch.

Accessories

- 6' Expandable Pole: \$37.00
- 12' Expandable Pole: \$46.00



Specially designed pole end fits into the ball on Sunset Shades for easy operation.

Color Lux® Cellular Specialty Shades SUNSET ARCHES

Sunset Features and Ordering Notes (Figure A)

- Sunset shades have horizontal pleats that stack at the bottom, on a stationary sill rail. Sunset shades are operated by a continuous cord that runs through a top mount guide block and back down through the stationary rail. A moving metal ball attached to the cord is used to raise and lower the shade. (See Figure E).
- **All Sunset arches which are not perfect half circles require a template.** A perfect arch is twice as wide as it is high. See page 111 for template instructions.
- **All templates should be made from brown craft paper.** Comfortex offers template kits. Please contact Customer Service to order. Stock number: 751000
- Sunset shades which are not perfect half circles must have a height which is equal to or greater than 25% of the width.
- When ordering Sunset shades that are perfect half circles, make sure the radius of the arch remains constant to ensure a proper fit. (See Figure B).
- **Stringing Method:** Depending on the curvature of a particular arch, it may be necessary to use the two string method (See Figure C) to ensure proper fit and operation of your Sunset shade. Comfortex will determine the best stringing method after examination of the template.
- **Arch Styles:** Sunset arches are available in a variety of styles including: palladium, eyebrow and bullet shaped arches. (See Figure D).

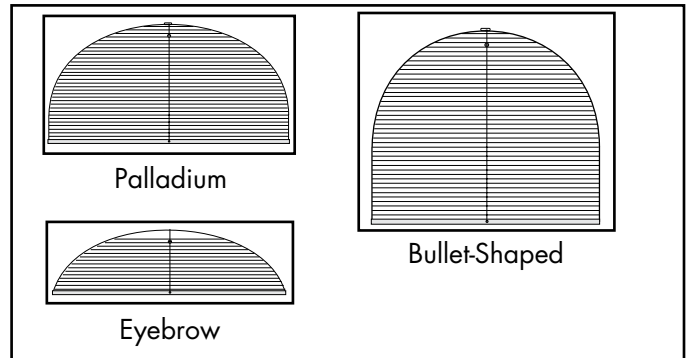

Figure D

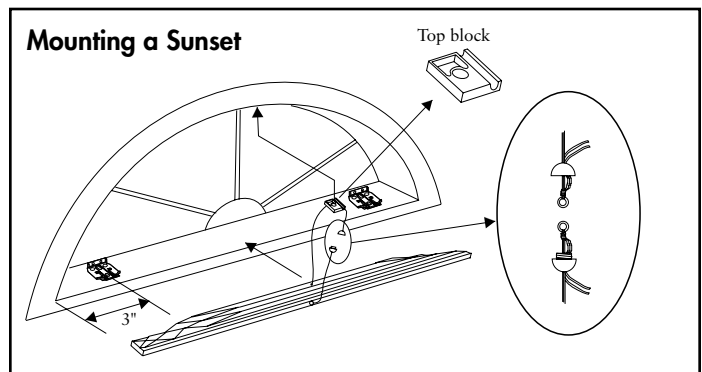

Figure E

Recommended Mounting Method for Side Mounting Shades

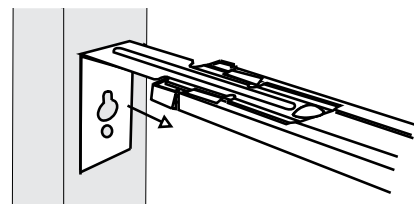
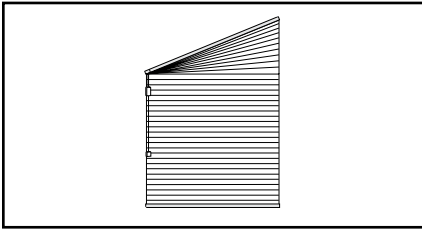

Figure F

Refer to the installation instructions on Comfortex.com or the OnDemand Mobile Library for further details on side mounting shades.

Color Lux® Cellular Specialty Shades TRAPEZOIDS AND OCTAGONS

Movable Trapezoids



Movable Octagons

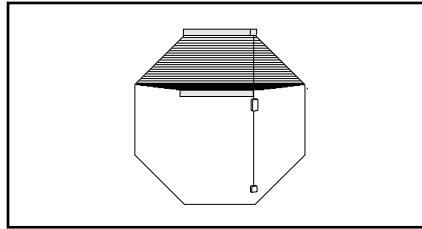

Hardware Features | See Page 17 for Rail Dimensions

Fabric Wrapped	Fabric used is same fabric as the shade. Back of rail is white to outside. Frosted clear end caps with white cord and tassel
Designer Metallic	<ul style="list-style-type: none"> • Oil Rubbed Bronze head and bottom rails with bronze colored tassel, end caps and white cord. • Brushed Nickel head and bottom rails and end caps with coordinating tassel and white cord.

Mounting Dimensions

Standard Cord Lock Rail

Minimum Shallow Mount	3/4"
Minimum Flush Inside Mount	2"
Minimum Outside Mount	3/4"
Minimum Side Mount	1 1/8"
Recommended Side Mounting Method	<ul style="list-style-type: none"> • See page 47 for recommended mounting method for side mount shades • Width limit for side mount brackets is 48"

Finished Dimensions

Inside and Side Mount

- Fabric will measure ordered width less: 3/8"
- Head rail* will measure ordered width less: 3/16"

Outside Mount

- Fabric will measure ordered width
- Head rail* will measure ordered width plus: 3/16"

Exact (End Cap to End Cap) Mount

- Fabric will measure ordered width less: 3/16"
- Head rail* will measure ordered width

* Head rail measurements include endcaps.
Width and length measurements may vary +/- 1/8"

Applications

- Movable Trapezoids
- Movable Octagons

Ordering Information for Trapezoid Shades

- Specify IB or OB mount and rail color.
- **Trapezoid orders must be faxed or emailed in with a diagram. Please provide measurements for all four sides when ordering. No template is required.**

Ordering Information for Octagon Shades

- Specify IB or OB mount and rail color.
- **The width, length and one side are required measurements when ordering.**

Color Lux® Cellular Specialty Shades TRAPEZOIDS AND OCTAGONS

Trapezoids (Figure A)

- Trapezoid orders must be faxed in with a diagram. Please provide measurements for all four sides when ordering. No template is required.
- The maximum slope of the top rail is 30 degrees from horizontal. Slope is the angle between slope and a horizontal line. The slope angle must be measured with a protractor.
- Sides of trapezoid must be parallel.
- Sill must be level for proper installation and operation of a trapezoid shade.
- Operating cord must be placed on the short side.
- See Figures B and C for trapezoid shade operation.

Octagons

- The width, length and one side are required measurements when ordering.
- Octagon shades raise only to the point where the top angle begins. (See Figure D)
- See Figure F on page 47 for recommend mounting method for side mount shades.
- Width limit for side mount brackets is 48".

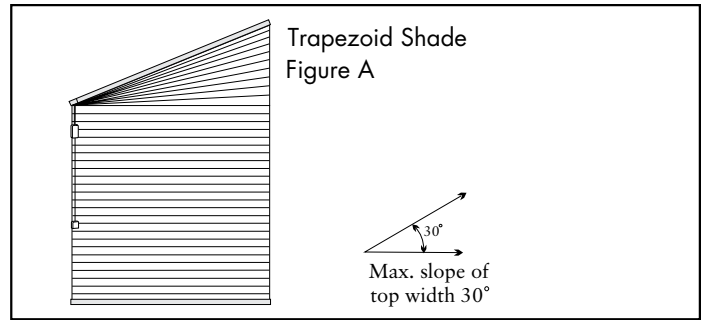

Trapezoid Shade Operation

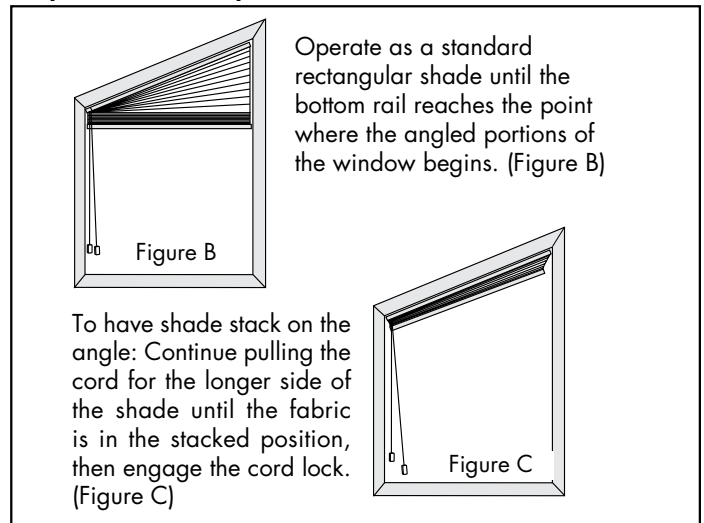

Octagon Operation

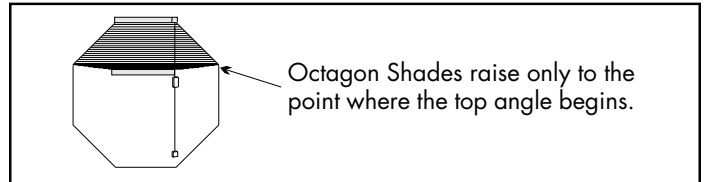
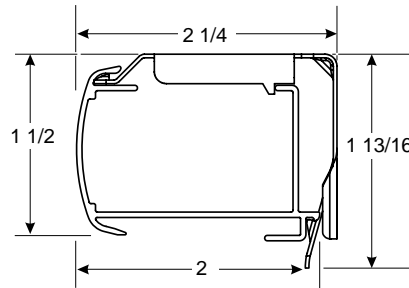

Figure D



Color Lux® Cellular Specialty Shades MEZZO MOTORIZED SKYLIGHT SHADES



Simplicity Motorized Rail Dimensions

- Depth of rail: 2"
- Depth of rail and bracket: 2 1/4"
- Height of rail: 1 1/2"
- Height of bracket: 1 13/16"

Hardware Features

Hardware colors	White head, bottom and side rails
Simplicity Remotes	Upper and lower limit stops pre-programmed, Intermediate stop "favorites" position can be set on site, 5 channel or 6 channel timer option

Mounting Dimensions

Mounting Dimensions	Mezzo Motorized Skylight Shades
Minimum Flush Inside Mount	2 1/2"
	<ul style="list-style-type: none"> • Should not be more than 1/2" out of square to perform as intended • The widest width of the window cannot exceed the narrowest width of the window by more than 3/8". • The shade must be mounted with the fabric stack at the bottom or the lowest point of the window
	See page 51 for Solar Panel information.

Finished Dimensions

Inside Mount

	<ul style="list-style-type: none"> • Fabric will measure ordered width less: 1 1/4" • Head rail* will measure ordered width less: 3/16"
* Head rail measurements include endcaps. Width and length measurements may vary +/- 1/8"	

MOTORIZATION - HARDWARE UPGRADE SURCHARGES AND ACCESSORIES All standard discounts apply to motorized shades		ADD
	Simplicity - Motor and Rechargeable Battery Pack	\$334
	Simplicity 5 Channel Remote	\$40
	Simplicity 6 Channel Remote with Timer	\$65
	48" Extension Wire:	\$18
	Simplicity Smart Controller (NEO)	\$330
	Solar Panel with brackets	\$75
	Plug In Charger: for rechargeable battery pack	\$54

Ordering Information for Mezzo Motorized Skylight Shades

- Specify inside mount dimensions.
- Specify fabric color and style.
- Specify remote and other accessories if needed.

Color Lux® Cellular Specialty Shades MEZZO MOTORIZED SKYLIGHT SHADES

Applications

- Horizontal, Angled and Vertical motorized skylight shades.

Mezzo Motorized Skylight Shades are for inside mount applications only.

Mezzo Power Options

- Simplicity Rechargeable Motor

RECHARGEABLE SIMPLICITY MOTORS

The Simplicity Motor program features a battery powered motor utilizing a rechargeable battery hidden inside the shade head rail. Simplicity motors are compact and use a radio frequency remote to raise or lower the shades.

Simplicity Rechargeable Battery

The rechargeable battery is concealed in the head rail of the shade. A charger is required for the rechargeable battery. The rechargeable battery comes fully charged from the factory.



Charging Port on Back of Head rail.

Simplicity Hand Held Remotes

The 5 Channel remote can operate up to five shades individually or in groups. **WHEN ORDERING PLEASE SPECIFY WHICH CHANNELS ARE ASSIGNED TO EACH SHADE OR GROUP OF SHADES.** For example; program line 1 to channel 1, line 2 and 3 to channel 2, etc. If no channels are assigned at time of order, all shades will be programmed to Channel 1. **To reprogram channel assignments, please refer to the installation instructions and/or view the video at comfortex.com/comfortex-dealers.**



A **6 Channel (6C) timer remote** is also available. See page 31 for more information

Simplicity remotes are black and holders are white or black in color. The remote comes with a holder which can be mounted to a wall for easy storage. The range of the remote is approximately 80 feet.

The Simplicity remote utilizes one 3V battery (CR2032). Batteries are included. Comfortex will warranty batteries for up to 3 months from date of purchase. Batteries are not covered by the warranty.

Solar Panel Recharge Option

Plugs in to any Simplicity Rechargeable Remote control shade (does not work with PowerTouch)

Provides constant trickle charge to 7.4v Li-Ion Rechargeable battery packs. Does not require direct sunlight, but performs best in regular direct sunlight applications. Will prolong the life of the charge of the 7.4v rechargeable battery packs, and in some applications will maintain charge indefinitely.

Life of charge is subject to application variables such as, size and weight of shade, frequency of use, amount of direct sunlight exposure, etc.



Dimensions of panel
18½" x 1½"

Solar Recharge Optimum Application

- Full direct sunlight (minimum 4-6 hours per day) to maintain full charge. Based on one operation cycle per day (one open, one close).
- Solar panel will charge batteries even without direct sunlight. Ambient light will charge the batteries but at a slower rate.
- Excessive duration of cloudy weather will impact the rate of charge.

Battery Charger

8.4 Volt charger requires a standard power outlet to recharge the battery wand. Must specify charger when ordering a Simplicity Rechargeable Wand Shade. The charger plugs into the charger port. The charger is black and comes with a 156" (13') wire. The dimensions are 1" wide x 2½" length x 1¾" deep.



Color Lux® Cellular Specialty Shades MEZZO MOTORIZED SKYLIGHT SHADES

Solar Panel Location Requirements

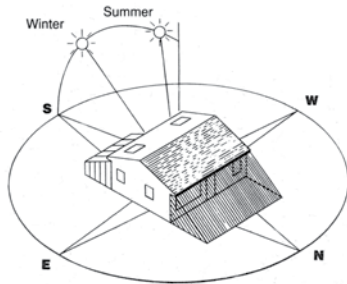

For Locations North of Washington, DC (39° Latitude)





For Locations South of Washington, DC (39° Latitude)



- Assumptions:** 1) Window area free from shadows 9 AM to 3 PM.
2) Glazing is double pane, clear.

Excessive shading or tinted glass will impact the solar charging capability of the system.

-  Indicates orientations which may require periodic manual recharge with Plug In Charger.
-  Indicates orientations which are optimum for solar recharge (wireless systems).

Retrofit Existing Standard Simplicity Motorized Shades with Rechargeable Batteries

Cellular shades made with Standard Simplicity Motorization can be retrofitted with the Rechargeable Simplicity Motorization Battery Wand. The Rechargeable battery wand is 22" long, comes with 10 NiMH batteries, and is white in color. Battery wands are charged at the factory.



Battery Wand for Rechargeable Simplicity Retrofit

See page 30 for further details. Please contact customer service for more information.

Important Simplicity Motorized Shades Operating and Installation Information

- Simplicity Motorized Shades installed into windows with metal casings may have a reduced radio frequency range, or may not operate at all, depending on the application.
- Do not let the antenna on the motor touch any metal objects. This may interfere with signals from the remote control.
- Make sure to leave the top of the shade head rail open (motor exposed), do not cover; especially with metal materials. This could result in a reduced radio frequency range for the remote control or the shade may not operate at all, depending on the application.



Color Lux® Cellular Specialty Shades FRENCH DOOR DÉCOR



Deluxe Head Rail

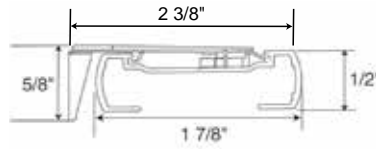

Deluxe Rail

- Depth of rail: 1 7/8"
- Depth of rail and bracket: 2 3/8"
- Height: 1/2"
- Height of bracket: 5/8"

Hardware Features	
Fabric Wrapped Upgrade	Fabric used is same fabric as the shade. Back of rail is white to outside. Frosted clear end caps with fabric insert.
Designer Metallic Upgrade	<ul style="list-style-type: none"> • Oil Rubbed Bronze head, middle, bottom rails and end caps. • Brushed Nickel head, middle, bottom rails and end caps.
Mounting Dimensions	
French Door Decor Hardware System	
Minimum Shallow Mount	3/4"
Minimum Flush Inside Mount	2 3/8"
Minimum Outside Mount	3/4"
Minimum Side Mount	1 3/8"
Recommended Side Mounting Method	<ul style="list-style-type: none"> • See page 47 for recommended mounting method for side mount shades • Width limit for side mount brackets is 48"
Finished Dimensions	
Inside and Side Mount	
	<ul style="list-style-type: none"> • Fabric will measure ordered width less: 3/8" • Head rail* will measure ordered width less: 3/16"
Outside Mount	
	<ul style="list-style-type: none"> • Fabric will measure ordered width • Head rail* will measure ordered width plus: 3/16"
Exact (End Cap to End Cap) Mount	
	<ul style="list-style-type: none"> • Fabric will measure ordered width less: 3/16" • Head rail* will measure ordered width
* Head rail measurements include endcaps. Width and length measurements may vary +/- 1/8"	

Color Lux® Cellular Specialty Shades DOOR DECOR

Applications

- Stationary Door Décor
- Movable Door Décor
- Top Down - Bottom Up Door Décor
- Cover French doors, transoms, and side lights.

French Door Décor Hardware Features

- Features two non-moving rails which are mounted in the window or door. A tension control system enables the movable rail to be easily moved with the touch of a finger. The only visible cords are the ones that hold the movable middle rail in place.
- The widest width of the window cannot exceed the narrowest width of the window by more than $\frac{3}{8}$ ".

Stationary Non-Movable French Door Décor Shades

- Top and bottom rails are mounted to the window and are stationary.

Movable French Door Décor Shades

- Top and bottom rails are mounted to the window, one middle movable rail raises from the bottom.

Top Down - Bottom Up Option

- Top and bottom rails are mounted to the window, two movable rails allow the shade to lower from the top and raise from the bottom.
- The non-movable top and bottom rails are attached to the window or door.
- Ideal for entry ways with narrow windows next to doors and other narrow windows that are easily accessible.

Ordering Information for French Door Décor

- Specify IB or OB mount and rail color.
 - Specify stationary, movable or Top Down - Bottom Up.
- You may want to specify hold down brackets if mounting on a door.

Accessories

- 6' Expandable Pole: \$37.00
- 12' Expandable Pole: \$46.00

Specially designed pole end allows for easy operation of French Door Décor Shades.

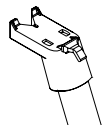

French Door Decor Cellular Shades Hardware

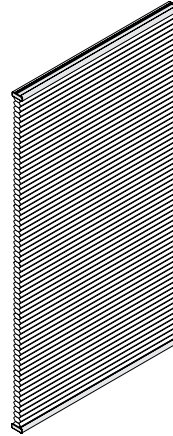

Stationary Non-Movable

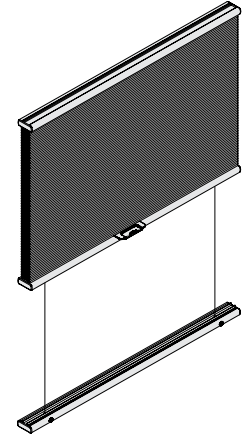

Shown open with movable rail option

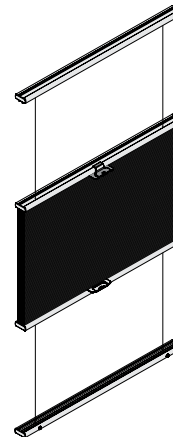

Shown open with Top Down - Bottom Up Option

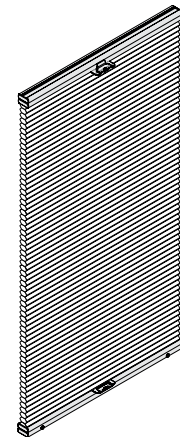

Shown closed with Top Down - Bottom Up Option

Color Lux® Cellular Specialty Shades DAY-NIGHT SHADES



Deluxe Head Rail

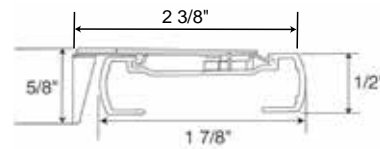

Deluxe Rail

- Depth of rail: 1 7/8"
- Depth of rail and bracket: 2 3/8"
- Height: 1/2"
- Height of bracket: 5/8"

Hardware Features

Fabric Wrapped Upgrade	Fabric used is same fabric as the shade. Back of rail is white to outside. Frosted clear end caps with fabric insert.
Designer Metallic Upgrade	<ul style="list-style-type: none"> • Oil Rubbed Bronze head and bottom rails with bronze colored tassel, end caps and white cord. • Brushed Nickel head and bottom rails and end caps with coordinating tassel and white cord.

Mounting Dimensions	Standard Cord Lock Rail
Minimum Shallow Mount	3/4"
Minimum Flush Inside Mount	2 3/8"
Minimum Outside Mount	3/4"
Minimum Side Mount	1 1/8"
Recommended Side Mounting Method	<ul style="list-style-type: none"> • See page 47 for recommended mounting method for side mount shades • Width limit for side mount brackets is 48"

Finished Dimensions

Inside and Side Mount	
	<ul style="list-style-type: none"> • Fabric will measure ordered width less: 3/8" • Head rail* will measure ordered width less: 3/16"
Outside Mount	
	<ul style="list-style-type: none"> • Fabric will measure ordered width • Head rail* will measure ordered width plus: 3/16"
Exact (End Cap to End Cap) Mount	
	<ul style="list-style-type: none"> • Fabric will measure ordered width less: 3/16" • Head rail* will measure ordered width
* Head rail measurements include endcaps. Width and length measurements may vary +/- 1/8"	

Applications

- Standard Rectangular with cellular fabrics only.

Day - Night Shade Specifications

Refer to the appropriate fabric sections for proper pricing.

Color Lux® Cellular Specialty Shades

DAY-NIGHT SHADES

Rail Colors and Cord Colors

- **Color Coordinated Rail Shades:** The top rail and middle rail will coordinate with top fabric and bottom rail will coordinate with the bottom fabric. The cord and tassel will be white. Not available with Color Lux Shades.
- **Designer Metallic Hardware Shades:** All rails, end caps and tassels will be the selected metallic color. Cords will be white.
- **Fabric Wrapped Rail Shades:** The top rail and middle rail will coordinate with top fabric and bottom rail will coordinate with the bottom fabric. The cord and tassel will be white. End caps and cord lock will be color coordinated.

Hardware Options

- Cord Lock

Ordering Information for Day - Night Shade

- Specify fabrics, top and bottom panels.
- Specify IB or OB mount and rail color.

TOP FABRIC

CELLULAR	Width		Length	
	Min	Max	Min	Max
NEW Verona	12"	72"	18"	96"
NEW Boutique	12"	72"	18"	96"
Baritone (all)*	12"	72"	18"	96"
Debut ½" Double Cell Light Filtering	12"	72"	18"	96"
Debut ¾" Single Cell Light Filtering	12"	72"	18"	96"
Color Lux Linen Weave Light Filtering*	12"	72"	18"	96"
Color Lux Linen Weave Room Darkening*	NA	NA	NA	NA
Linen Weave Light Filtering*	12"	72"	18"	96"
Linen Weave Room Darkening*	NA	NA	NA	NA
Premiere ¾" Single Cell Blackout	NA	NA	NA	NA
Premiere ¾" Single Cell Light Filtering	12"	72"	18"	96"

BOTTOM FABRIC

Width		Length	
Min	Max	Min	Max
12"	72"	18"	96"
12"	72"	18"	96"
12"	72"	18"	96"
12"	72"	18"	96"
12"	72"	18"	96"
12"	72"	18"	96"
12"	72"	18"	96"
12"	72"	18"	96"
12"	72"	18"	96"
12"	72"	18"	96"

* Day-Night Shades can only be built in conjunction with other ¾" cellular fabrics. All Debut includes print patterns: Strie, Terazzo, Angel Hair, Strat, Florance, Blossom, Country Woven and Homespun.

Color Lux® Cellular Shades HIGHLIGHTS CORNICE VALANCE



Highlights Cornice Valances

Highlight any element of your home décor with the Highlights Cornice Valance upgrade.

This tailored, fabric wrapped 6-inch valance, available with seven returns sized from 1½" to 6", mounts over any product, either inside or outside the frame. The keystone option now allows for all Color Lux Roller fabrics to cover widths up to 216".

Highlights Valance without a keystone can be added to your cellular shade order or as a stand alone product. Highlights Valance orders with a keystone are a stand alone product only.

EZ Level on Comfortex Cellular Shades

EZ Level makes quick work of leveling without cords to cut or tuck into a rail. No special tools needed – just use a nickel, quarter or penny to adjust plug on the bottom rail.

EZ Level is standard on all Cellular and Pleated Shades with the following hardware systems:

- Standard and Deluxe Cord Lock
- Cordless Ultra
- Cord Loop
- SlumberShades
- Simplicity Motorized Systems

EZ Level is not available with Lift & Lock Cordless.

How does EZ Level work?

- Slightly raise the bottom rail you want to level.
- Insert a coin or flat head screwdriver into the adjustment screw and turn it.
- Turn the adjustment screw clockwise or counter clockwise to make slight adjustments up or down.









- One quarter turn of the adjustment screw will move the bottom rail up or down ¼".
- Lower the rail to check the level and make further adjustments if necessary.

Color Lux® Roller Shades



COLOR LUX
Designer Cellular & Roller Shades





Color Lux® Roller Shade Hardware Options

	Key Features	Control Options	Hardware Color Options	Hardware Size (Depth x Height)	Roll Style
Skyline Roller Only 	<ul style="list-style-type: none"> • Skyline System • Sturdy aluminum tube for durability • Perfect under top treatments • Cord loop length does not change while operating shade 	<ul style="list-style-type: none"> • Cord Loop • Motorization 	<ul style="list-style-type: none"> • White, • Vanilla, • Black, • Bronze and • Satin Nickel <p>Clutch, Bracket Covers, Bead Chain and Tensioner</p>	<p>Standard 2½" x 2¾" 2¼" x 2⅞"</p>	<p>Standard</p> <p>Reverse</p>
Designer Cassette with Fabric Insert Strip 	<ul style="list-style-type: none"> • Cassette head rail features a matching fabric insert • Hides the roller shade mechanism for a tailored appearance 	<ul style="list-style-type: none"> • Cord Loop • Cordless • Motorization 	<ul style="list-style-type: none"> • White • Ivory • Black • Satin Nickel • Oil Rubbed Bronze <p>All with fabric insert strip</p>	<p>3¾" x 2⅞"</p>	<p>Standard</p>
Designer Cassette with Fabric Wrap 	<ul style="list-style-type: none"> • Head rail is wrapped with matching shade fabric • Head rail is white, black or oil rubbed bronze beneath the fabric wrap • Hides the mechanism for a soft appearance from top to bottom 	<ul style="list-style-type: none"> • Cord Loop • Cordless • Motorization 	<ul style="list-style-type: none"> • White • Ivory • Black • Satin Nickel • Oil Rubbed Bronze <p>All with fabric wrap</p>	<p>3¾" x 2⅞"</p>	<p>Standard</p>
Designer Cassette with Metallic Finish 	<ul style="list-style-type: none"> • Smooth finish head rail hides the roller shade mechanism • High quality finish for a modern appearance 	<ul style="list-style-type: none"> • Cord Loop • Cordless • Motorization 	<ul style="list-style-type: none"> • White • Ivory • Black • Satin Nickel • Oil Rubbed Bronze 	<p>3¾" x 2⅞"</p>	<p>Standard</p>
Cordless with Deco-Bar 	<ul style="list-style-type: none"> • Cord-free system • Operates like a spring roller shade with a gentle pull on the bottom rail to raise and lower the shade • Smooth and quiet operation • Ideal from homes with children and pets • Clear handle included to ensure clean bottom rail 	<ul style="list-style-type: none"> • Cordless 	<ul style="list-style-type: none"> • White • Black • Ivory • Satin Nickel • Bronze <p>Color Coordinated Bracket Covers</p>	<p>Shades to 72" (varies by fabric) 1½" x 2¼"</p> <p>Over 72" (varies by fabric) 1¾" x 2¾"</p>	<p>Standard</p> <p>Reverse</p>
Simplicity Motorization 	<ul style="list-style-type: none"> • Raise and lower shades at the push of a button; ideal for larger shades • Child and pet safe • Operate multiple shades simultaneously • Battery wand included; power supply option available 	<ul style="list-style-type: none"> • Simplicity 	<ul style="list-style-type: none"> • Skyline Roller • Designer Cassette (All) • 4" Skyline Fascia <p>See above for color options</p>	<p>See Above</p> <p>Minimum Shade Width is 14"</p>	<p>Standard</p> <p>Reverse with Standard Roller</p>
PowerTouch Rechargeable 	<ul style="list-style-type: none"> • Raise & lower shading with the push of a button • Eliminate the need to stand by the shading to operate; just touch and go • Favorite position button • Rechargeable battery with recharge port on pendant • Features a favorite position 	<ul style="list-style-type: none"> • Simplicity 	<ul style="list-style-type: none"> • Skyline Roller • Designer Cassette (All) <p>Wand and Pendant available in white or black</p>	<p>Designer Cassette: 3¾" x 2⅞"</p> <p>No Head Rail: Varies by shade size</p>	<p>Standard</p> <p>Reverse with Standard Roller</p>





COLOR LUX® ROLLER SHADES

Color Lux® Roller Shade Hardware Options

COLOR LUX® ROLLER SHADES

	Key Features	Control Options	Hardware Color Options	Hardware Size (Depth x Height)	Roll Style
Simplicity Rechargeable Motorization 	<ul style="list-style-type: none"> Rechargeable motor is fully integrated within the roller tube No additional battery wand needs to be installed Battery lasts 6 to 12 months between charges (varies by size and usage) 	<ul style="list-style-type: none"> Simplicity 	<ul style="list-style-type: none"> Standard Roller Designer Cassette (All) 	Minimum Shade Width is 18" Max size varies by fabric	Standard Reverse with Standard Roller
4" Skyline Fascia 	<ul style="list-style-type: none"> Conceals the Skyline Roller hardware system Cornice look Cord Loop and Motorization Fascia coordinates with all Skyline colors 	<ul style="list-style-type: none"> Cord Loop Motorization 	<ul style="list-style-type: none"> Black Brushed Nickel Vanilla Bronze White 	4" x 4"	Standard
Simplicity Wave for Roller Shades 	<ul style="list-style-type: none"> Rechargeable motor is fully integrated within the roller tube Motor is operated via a separate wand that operates the shade with a touch of the head rail. Easy operation for hard to reach places 	<ul style="list-style-type: none"> Simplicity 	<ul style="list-style-type: none"> Designer Cassette (All) See above for color options	Minimum Shade Width is 18" Max size varies by fabric	Standard
Designer Cassette with Retractable Cord 	<ul style="list-style-type: none"> Cords are white or black and coordinate with the clutch selected Smooth and simple operation Does not require a cord tensioner Ideal for out of reach shades 	<ul style="list-style-type: none"> White or Black Retractable Cord Left or Right hand control 	<ul style="list-style-type: none"> White Ivory Black Satin Nickel Oil Rubbed Bronze 	3¾" x 2⅞"	Standard

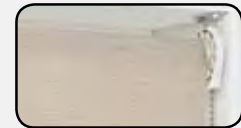
Color Lux Roller Decorative Options

Highlights Cornice Valances 	<ul style="list-style-type: none"> Keystone for widths up to 216". Available in all Color Lux Roller Fabrics Coordinate all your shades and décor for a unified look Hide any roller hardware mechanism 	<ul style="list-style-type: none"> Available as inside and outside mount Seven return options to fit any window 	<ul style="list-style-type: none"> Fabric Wrapped 	Width: 24" to 216" (includes returns) Height: 6" Returns: 1½" to 6"	NA
Bottom Rails 	<ul style="list-style-type: none"> Add an a decorative accent to bottom of your shade or fabric wrap the bottom rail for a soft look. Two clear plastic end caps secure the fabric in place. 	All hardware	<ul style="list-style-type: none"> White Black Bronze Aluminum Vanilla For fabric wrap, rail colors are street side only	NA	NA
Reverse Roll 	<ul style="list-style-type: none"> The fabric rolls from the front of the roller, concealing the hardware. 	<ul style="list-style-type: none"> Standard Roller Cordless Deco-Bar Standard Roller with Motorization 	See page 88 for color options for your hardware selection	See page 70 & 71 for hardware size	NA
Standard Roll 	<ul style="list-style-type: none"> Fabric rolls off the back of the roller 	<ul style="list-style-type: none"> Standard Roller Cordless Deco-Bar Motorization 	See page 88 for color options for your hardware selection	See page 70 & 71 for hardware size	NA

Color Lux Skyline Hardware Roller Shades

Color Lux provides beautiful color coordination for various hardware options to provide ultimate roller shade design and quality. White, Ivory and Black Skyline hardware is standard on all Color Lux Roller shades. All components are color coordinated, including clutch, bracket covers, bead chain and the tensioner. See individual price grids for pricing.

Skyline Hardware in White



Designer Cassette with Skyline Hardware



Standard Roller with Skyline Hardware



4" Skyline Fascia

Clutch, Cassette, Bead Chain, Brackets, Bracket Covers and Tensioner are in White

Skyline Hardware in Ivory



Designer Cassette with Skyline Hardware



Standard Roller with Skyline Hardware



4" Skyline Fascia

Clutch, Cassette, Bead Chain, Brackets, Bracket Covers and Tensioner are in Ivory

Skyline Hardware in Black



Designer Cassette with Skyline Hardware



Standard Roller with Skyline Hardware

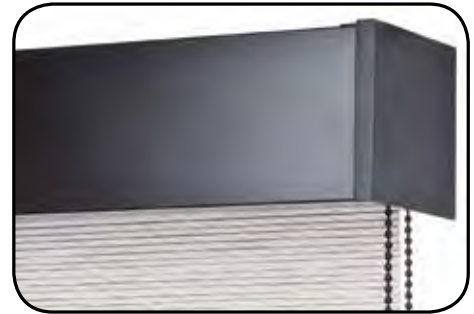

4" Skyline Fascia

Clutch, Cassette, Bead Chain, Brackets, Bracket Covers and Tensioner are in Black

Color Lux Skyline Hardware Roller Shades

Skyline Hardware in Satin Nickel

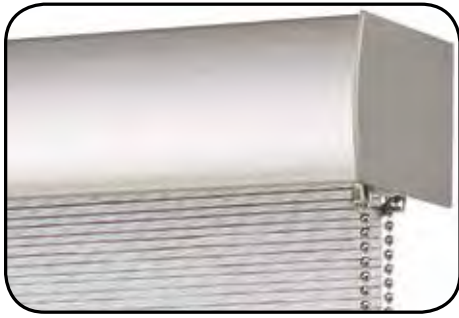

Designer Cassette with Skyline Hardware

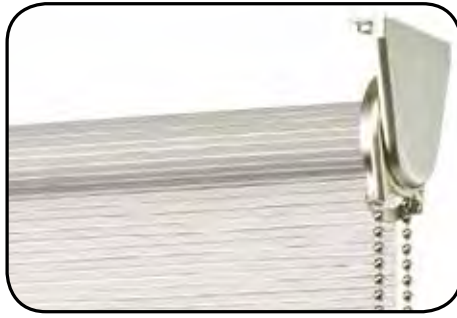

Standard Roller with Skyline Hardware

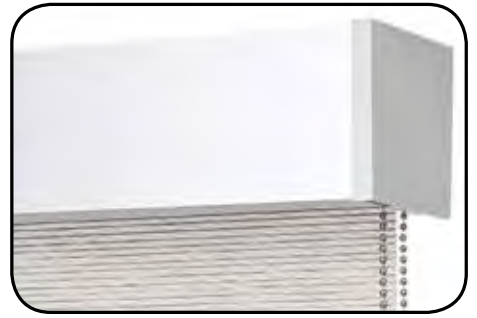

4" Skyline Fascia

Clutch, Cassette, Bead Chain, Bracket, Bracket Covers and Tensioner are in Satin Nickel.

Skyline Hardware in Bronze



Designer Cassette with Skyline Hardware



Standard Roller with Skyline Hardware



4" Skyline Fascia

Clutch, Cassette, Bead Chain, Brackets, Bracket Covers and Tensioner are in Bronze

Dual Roller Shades



Black and White Brackets



Mix and Match Light Filtering and Blackout Fabrics

Dual Roller Shades are available with Remote Motorization and Cord Loop Control

COLOR LUX® ROLLER SHADES

Color Lux Skyline Hardware Pricing and Surcharges Cord Loop Options



Skyline Hardware in White



Skyline Hardware in Ivory



Skyline Hardware in Black



Skyline Hardware in Bronze



Skyline Hardware in Satin Nickel

Motorization Options



PowerTouch Rechargeable in White (Also Available in Black)



Motorized 4" Fascia in White



Motorized 4" Fascia Ivory

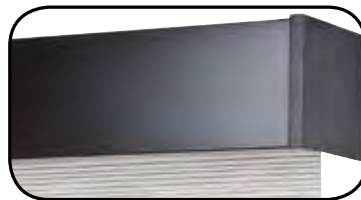

Motorized 4" Fascia in Black

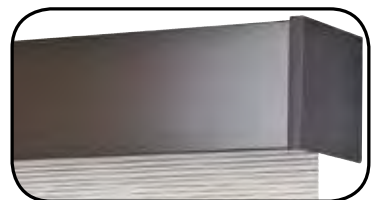

Motorized 4" Fascia in Bronze



Motorized 4" Fascia in Satin Nickel

Skyline Standard Roller Shade

Price Group 17 | Classic Duck Light Filtering

		Width In Inches																				
		24	30	36	42	48	54	60	66	72	78	84	90	96	102	106	112	118	124	130	136	144
Length In Inches	36	196	217	241	267	297	329	366	413	459	509	579	638	687	742	801	820	976	1064	1162	1270	1385
	42	201	223	247	275	305	338	376	424	471	523	594	654	706	763	823	839	1002	1092	1195	1303	1424
	48	206	229	255	283	314	349	386	435	483	536	610	671	725	782	846	862	1029	1122	1225	1338	1460
	54	213	234	260	289	321	356	396	446	496	550	626	687	744	803	867	885	1055	1151	1255	1371	1499
	60	217	241	267	296	329	365	406	459	509	564	641	705	761	822	887	905	1081	1179	1289	1406	1535
	66	223	246	274	304	337	375	416	468	521	578	656	722	779	842	910	928	1107	1208	1319	1441	1572
	72	228	254	280	313	346	383	425	480	533	591	673	739	799	862	933	950	1133	1238	1350	1475	1611
	78	233	258	288	318	353	391	435	492	544	605	687	756	817	883	952	973	1160	1266	1382	1510	1717
	84	238	264	293	325	361	402	446	501	558	618	704	774	836	903	974	994	1185	1295	1413	1541	1830
	90	244	270	300	333	369	410	454	513	570	632	718	791	854	939	1006	1016	1212	1324	1445	1577	1951
	96	249	276	306	342	378	418	464	525	581	646	735	809	874	979	1030	1038	1239	1352	1476	1681	2080
	102	255	283	313	347	385	428	475	536	595	659	750	825	891	1005	1051	1120	1321	1441	1573	1792	2217
	108	259	288	320	354	394	437	484	546	608	674	766	842	910	1009	1085	1157	1408	1536	1677	1910	2363
	114	264	293	325	361	402	446	495	558	620	687	782	859	929	1034	1116						
120	270	300	333	369	410	454	504	569	632	701	797	877	947	1051	1158							
126	275	305	339	378	417	464	513	580	645	715	812	894	968	1074	1174							
132	283	313	347	385	426	474	525	592	657	730	829	912	986	1096	1239							
138	288	318	353	392	435	483	535	604	671	744	846	930	1006	1113	1261							
144	293	324	359	401	443	493	545	616	684	758	862	949	1028	1157	1301							

Classic Duck Light Filtering: Minimum standard shade size is 12" x 12". Maximum shade width is 106" and it can be railroaded to a maximum width of 144" and a maximum length of 108".

Head Rail Options and Surcharges

Section 1 & 2	Available: Skyline Hardware (All), Designer Cassette (All), Cordless Deco-Bar, 4" Skyline Fascia, Motorization, PowerTouch Rechargeable
Section 3	Available: Skyline Roller Only with Cordloop, Heavy Duty Motorization (Roller Only), 4" Skyline Fascia with Cord Loop (Dual Roller Not Available)
Section 4	Available: Skyline Roller Only with Cordloop, and Heavy Duty Motorization (Roller Only) (Dual Roller Not Available)

Skyline Clutch Surcharge

White, Ivory and Black	No Charge
Satin Nickel and Bronze	Add \$27 to standard rectangular price

Designer Cassette

	24	30	36	42	48	54	60	66	72	78	84	90	96	102	108	114	120
White, Ivory, Black, Brushed Nickel and Oil Rubbed Bronze Includes Smooth, Fabric Wrap and Insert Strip Option	74	80	86	92	98	106	113	120	127	122	129	140	145	149	154	176	198

4" Skyline Fascia

	24	30	36	42	48	54	60	66	72	78	84	90	96	102	108	114	120
White, Ivory, Black, Brushed Nickel and Oil Rubbed Bronze 4" Skyline Fascia	61	67	69	70	80	92	101	111	122	130	142	154	161	170	182	191	200

Cordless Roller

Cordless with Deco-Bar*	Add \$40
Cordless with Cassette	Add \$40 PLUS the Designer Cassette Surcharge to Standard Rectangular Price

*Minimum width is 15½", Maximum width is 96", Maximum length is 96"

Retractable Cord with Designer Cassette

White and Black Retractable Cord	Add \$40 PLUS the Designer Cassette Surcharge to Standard Rectangular Price
----------------------------------	---

Dual Roller Shades

White and Black Brackets	Price as two separate roller shades with desired options. Add \$27 to total.
--------------------------	--

Two on One Head Rail: Price as two separate roller shades with Designer Cassette option and add together.

Highlights Cornice Valance

	24	30	36	42	48	54	60	66	72	78	84	94	102	106	112	118	124	130	136	144
Highlights Cornice Valance (No Keystone)	91	101	110	119	130	136	143	150	156	162	169	180	Requires keystone. See pricing below							
Highlights Cornice Valance (with Keystone)	122	132	142	150	161	167	174	181	187	193	200	211	227	234	242	251	259	269	278	288

Highlights Valance with Keystone: All valances made over 94" wide will require a keystone (shaded area).

Scotchgard™ Stain Protection

Scotchgard™ Stain Protection	Add \$35 to the standard rectangular price
------------------------------	--

Bottom Rail Tassel Pulls: See page 86 for pricing and details.

Motorization: See pages 89 - 95 for all motorization options.

NEW Simplicity Wave for Roller: See pages 76 & 89 for more information.
 NEW Solar Panel Option for Simplicity Rechargeable Shades with Remote: See page 95.
 NEW Heavy Duty Roller Motors: See page 91 for more information.

Tube Information for Clutch Operated Shades Only

- **Section 1:** Shades to the left of the dashed line requires a 1" tube/SL10" clutch
- **Section 2:** Shades to the right of the dashed line requires a 1½" tube/SL10 clutch
- **Section 3:** Shades in the blue section requires a 2" tube/SL20 clutch.
- **Section 4:** Shades in the orange section requires a 2½" tube/Galaxy 200 clutch

COLOR LUX® ROLLER SHADES

Skyline Standard Roller Shade

Price Group 18 | Classic Duck Blackout

Width In Inches

	24	30	36	42	48	54	60	66	72	78	84	90	96	102	106	112	118	124	130	136	144
36	215	239	265	294	327	362	403	454	504	560	637	702	756	817	881	900	1073	1172	1279	1397	1524
42	220	245	272	303	336	373	413	467	519	575	653	719	776	839	906	924	1102	1202	1315	1432	1567
48	227	252	280	311	345	384	424	478	532	590	671	738	797	861	930	948	1130	1235	1348	1472	1607
54	235	258	286	318	353	391	436	491	545	604	689	756	819	884	954	975	1160	1266	1382	1509	1713
60	239	265	294	326	362	402	446	504	560	621	705	775	837	904	976	996	1188	1297	1417	1546	1826
66	245	271	302	334	372	412	457	514	572	635	721	795	857	926	1001	1022	1219	1329	1450	1586	1947
72	250	279	308	344	380	421	468	528	587	650	740	812	879	948	1026	1044	1246	1361	1484	1691	2076
78	257	284	317	350	388	431	478	541	599	667	756	831	898	971	1047	1070	1276	1393	1520	1803	2213
84	262	291	322	357	397	442	491	551	614	680	774	852	920	993	1071	1094	1304	1424	1620	1922	2359
90	269	297	330	366	407	451	500	565	627	696	790	869	940	1033	1106	1118	1334	1456	1727	2049	2515
96	274	304	337	376	416	460	510	578	639	710	808	890	960	1077	1133	1142	1363	1487	1841	2184	2681
102	280	311	344	382	423	471	523	590	655	726	826	908	980	1105	1156	1217	1453	1585	1963	2328	2858
108	285	317	352	389	434	480	533	601	669	741	842	926	1001	1111	1193	1297	1549	1690	2093	2482	3047
114	291	322	357	397	442	491	544	614	682	756	861	945	1023	1137	1228						
120	297	330	366	407	451	500	555	626	696	771	877	965	1042	1156	1274						
126	303	336	374	416	459	510	565	638	709	787	894	983	1065	1182	1291						
132	311	344	382	423	469	522	578	651	723	803	912	1003	1085	1206	1363						
138	317	350	388	432	478	532	589	664	738	819	930	1024	1106	1224	1387						
144	322	356	395	441	487	542	600	678	752	833	948	1044	1130	1273	1431						

Classic Duck Blackout: Minimum standard shade size is 12" x 12". Maximum shade width is 106" and it can be railroaded to a maximum width of 144" and a maximum length of 108"

Head Rail Options and Surcharges

Section 1 & 2	Available: Skyline Hardware (All), Designer Cassette (All), Cordless Deco-Bar, 4" Skyline Fascia, Motorization, PowerTouch Rechargeable
Section 3	Available: Skyline Roller Only with Cordloop, Heavy Duty Motorization (Roller Only), 4" Skyline Fascia with Cord Loop (Dual Roller Not Available)
Section 4	Available: Skyline Roller Only with Cordloop, and Heavy Duty Motorization (Roller Only) (Dual Roller Not Available)

Skyline Clutch Surcharge

White, Ivory and Black	No Charge
Satin Nickel and Bronze	Add \$27 to standard rectangular price

Designer Cassette 24 30 36 42 48 54 60 66 72 78 84 90 96 102 108 114 120

White, Ivory, Black, Brushed Nickel and Oil Rubbed Bronze Includes Smooth, Fabric Wrap and Insert Strip Option	74	80	86	92	98	106	113	120	127	122	129	140	145	149	154	176	198
---	----	----	----	----	----	-----	-----	-----	-----	-----	-----	-----	-----	-----	-----	-----	-----

4" Skyline Fascia 24 30 36 42 48 54 60 66 72 78 84 90 96 102 108 114 120

White, Ivory, Black, Brushed Nickel and Oil Rubbed Bronze 4" Skyline Fascia	61	67	69	70	80	92	101	111	122	130	142	154	161	170	182	191	200
--	----	----	----	----	----	----	-----	-----	-----	-----	-----	-----	-----	-----	-----	-----	-----

Cordless Roller

Cordless with Deco-Bar*	Add \$40
Cordless with Cassette	Add \$40 PLUS the Designer Cassette Surcharge to Standard Rectangular Price

*Minimum width is 15½", Maximum width is 96", Maximum length is 96"

Retractable Cord with Designer Cassette

White and Black Retractable Cord	Add \$40 PLUS the Designer Cassette Surcharge to Standard Rectangular Price
----------------------------------	---

Dual Roller Shades

White and Black Brackets	Price as two separate roller shades with desired options. Add \$27 to total.
--------------------------	--

Two on One Head Rail: Price as two separate roller shades with Designer Cassette option and add together.

Highlights Cornice Valance 24 30 36 42 48 54 60 66 72 78 84 94 102 106 112 118 124 130 136 144

Highlights Cornice Valance (No Keystone)	91	101	110	119	130	136	143	150	156	162	169	180	Requires keystone. See pricing below							
Highlights Cornice Valance (with Keystone)	122	132	142	150	161	167	174	181	187	193	200	211	227	234	242	251	259	269	278	288

Highlights Valance with Keystone: All valances made over 94" wide will require a keystone (shaded area).

Scotchgard™ Stain Protection

Scotchgard™ Stain Protection	Add \$35 to the standard rectangular price
------------------------------	--

Bottom Rail Tassel Pulls: See page 86 for pricing and details.

Motorization: See pages 89 - 95 for all motorization options.

NEW Simplicity Wave for Roller: See pages 76 & 89 for more information.

NEW Solar Panel Option for Simplicity Rechargeable Shades with Remote: See page 95.

NEW Heavy Duty Roller Motors: See page 91 for more information.

Tube Information for Clutch Operated Shades Only

- **Section 1:** Shades to the left of the dashed line requires a 1" tube/SL10" clutch
- **Section 2:** Shades to the right of the dashed line requires a 1½" tube/SL10 clutch
- **Section 3:** Shades in the blue section requires a 2" tube/SL20 clutch.
- **Section 4:** Shades in the orange section requires a 2½" tube/ Galaxy 200 clutch

Skyline Standard Roller Shade

Price Group 19 | Linen Light Filtering

		Width In Inches																				
		24	30	36	42	48	54	60	66	72	78	84	90	96	102	106	112	118	124	130	136	144
Length In Inches	36	215	239	265	294	327	362	403	454	504	560	637	702	756	817	881	901	1073	1171	1278	1397	1524
	42	220	245	272	303	336	373	413	467	519	575	653	719	776	839	906	923	1102	1202	1315	1433	1567
	48	227	252	280	311	345	384	424	478	532	590	671	738	797	861	930	948	1131	1234	1348	1472	1606
	54	235	258	286	318	353	391	436	491	545	604	689	756	819	884	954	974	1160	1266	1381	1509	1649
	60	239	265	294	326	362	402	446	504	560	621	705	775	837	904	976	995	1188	1297	1418	1546	1667
	66	245	271	302	334	372	412	457	514	572	635	721	795	857	926	1001	1022	1218	1329	1450	1585	1690
	72	250	279	308	344	380	421	468	528	587	650	740	812	879	948	1026	1045	1247	1362	1484	1623	1715
	78	257	284	317	350	388	431	478	541	599	667	756	831	898	971	1047	1070	1276	1392	1520	1630	1863
	84	262	291	322	357	397	442	491	551	614	680	774	852	920	993	1071	1093	1304	1424	1467	1635	1919
	90	269	297	330	366	407	451	500	565	627	696	790	869	940	1033	1106	1118	1333	1456	1500	1649	1977
	96	274	304	337	376	416	460	510	578	639	710	808	890	960	1077	1133	1142	1363	1487	1532	1838	2036
	102	280	311	344	382	423	471	523	590	655	726	826	908	980	1105	1156	1176	1404	1532	1711	1893	2097
	108	285	317	352	389	434	480	533	601	669	741	842	926	1001	1111	1193	1211	1446	1578	1763	1950	2160
	114	291	322	357	397	442	491	544	614	682	756	861	945	1023	1137	1228						
120	297	330	366	407	451	500	555	626	696	771	877	965	1042	1156	1274							
126	303	336	374	416	459	510	565	638	709	787	894	983	1065	1182	1291							
132	311	344	382	423	469	522	578	651	723	803	912	1003	1085	1206	1363							
138	317	350	388	432	478	532	589	664	738	819	930	1024	1106	1224	1387							
144	322	356	395	441	487	542	600	678	752	833	948	1044	1130	1273								

Color Lux Linen Light Filtering: Minimum standard shade size is 12" x 12". Maximum shade width is 106" and it can be railroaded to a maximum width of 144" and a maximum length of 108".

Head Rail Options and Surcharges

Section 1 & 2	Available: Skyline Hardware (All), Designer Cassette (All), Cordless Deco-Bar, 4" Skyline Fascia, Motorization, PowerTouch Rechargeable
Section 3	Available: Skyline Roller Only with Cordloop, Heavy Duty Motorization (Roller Only), 4" Skyline Fascia with Cord Loop (Dual Roller Not Available)
Section 4	Available: Skyline Roller Only with Cordloop, and Heavy Duty Motorization (Roller Only) (Dual Roller Not Available)

Skyline Clutch Surcharge

White, Ivory and Black	No Charge
Satin Nickel and Bronze	Add \$27 to standard rectangular price

Designer Cassette

White, Ivory, Black, Brushed Nickel and Oil Rubbed Bronze Includes Smooth, Fabric Wrap and Insert Strip Option	24	30	36	42	48	54	60	66	72	78	84	90	96	102	108	114	120
	74	80	86	92	98	106	113	120	127	122	129	140	145	149	154	176	198

4" Skyline Fascia

White, Ivory, Black, Brushed Nickel and Oil Rubbed Bronze 4" Skyline Fascia	24	30	36	42	48	54	60	66	72	78	84	90	96	102	108	114	120
	61	67	69	70	80	92	101	111	122	130	142	154	161	170	182	191	200

Cordless Roller

Cordless with Deco-Bar*	Add \$40
Cordless with Cassette	Add \$40 PLUS the Designer Cassette Surcharge to Standard Rectangular Price

*Minimum width is 15½", Maximum width is 96", Maximum length is 96"

Retractable Cord with Designer Cassette

White and Black Retractable Cord	Add \$40 PLUS the Designer Cassette Surcharge to Standard Rectangular Price
----------------------------------	---

Dual Roller Shades

White and Black Brackets	Price as two separate roller shades with desired options. Add \$27 to total.
--------------------------	--

Two on One Head Rail: Price as two separate roller shades with Designer Cassette option and add together.

Highlights Cornice Valance

Highlights Cornice Valance (No Keystone)	24	30	36	42	48	54	60	66	72	78	84	94	102	106	112	118	124	130	136	144
	91	101	110	119	130	136	143	150	156	162	169	180	Requires keystone. See pricing below							
Highlights Cornice Valance (with Keystone)	122	132	142	150	161	167	174	181	187	193	200	211	227	234	242	251	259	269	278	288

Highlights Valance with Keystone: All valances made over 94" wide will require a keystone (shaded area).

Scotchgard™ Stain Protection

Scotchgard™ Stain Protection	Add \$35 to the standard rectangular price
------------------------------	--

Bottom Rail Tassel Pulls: See page 86 for pricing and details.

Motorization: See pages 89 - 95 for all motorization options.

NEW Simplicity Wave for Roller: See pages 76 & 89 for more information.

NEW Solar Panel Option for Simplicity Rechargeable Shades with Remote: See page 95.

NEW Heavy Duty Roller Motors: See page 91 for more information.

Tube Information for Clutch Operated Shades Only

- **Section 1:** Shades to the left of the dashed line requires a 1" tube/SL10" clutch
- **Section 2:** Shades to the right of the dashed line requires a 1½" tube/SL10 clutch
- **Section 3:** Shades in the blue section requires a 2" tube/SL20 clutch.
- **Section 4:** Shades in the orange section requires a 2½" tube/ Galaxy 200 clutch

COLOR LUX® ROLLER SHADES

Skyline Standard Roller Shade

Price Group 20 | Linen Blackout

		Width In Inches																				
		24	30	36	42	48	54	60	66	72	78	84	90	96	102	106	112	118	124	130	136	144
Length In Inches	36	239	265	294	326	363	403	447	504	560	622	707	779	838	907	978	1000	1191	1301	1420	1551	1691
	42	244	272	302	336	374	414	459	519	575	639	725	798	862	932	1005	1026	1223	1334	1460	1590	1740
	48	252	279	312	345	383	426	471	531	591	655	744	819	885	956	1033	1053	1254	1370	1496	1633	1784
	54	261	286	317	353	392	435	483	544	605	671	765	838	909	981	1059	1083	1288	1406	1534	1675	1902
	60	265	294	326	362	403	446	495	560	622	689	782	860	929	1003	1084	1105	1319	1440	1573	1716	2028
	66	272	301	335	372	412	457	508	571	635	706	801	882	951	1028	1111	1134	1354	1475	1609	1829	2162
	72	278	311	343	382	421	468	520	586	651	721	822	901	975	1053	1139	1159	1383	1511	1648	1950	2305
	78	285	315	352	388	431	478	531	601	666	740	838	922	997	1077	1162	1188	1417	1546	1757	2079	2457
	84	291	323	357	396	441	491	544	612	681	755	859	946	1022	1101	1189	1214	1448	1580	1873	2216	2619
	90	299	330	366	407	451	501	555	627	697	772	877	965	1043	1147	1229	1241	1481	1684	1997	2362	2792
	96	304	337	375	417	462	510	566	641	709	788	897	988	1066	1196	1258	1267	1513	1795	2129	2518	2976
	102	312	345	382	424	470	523	581	655	728	805	917	1007	1088	1226	1283	1351	1613	1914	2270	2684	3173
	108	316	352	390	432	481	533	592	668	742	823	936	1028	1111	1233	1325	1440	1720	2040	2420	2861	3383
	114	323	357	396	441	491	544	604	681	757	838	956	1048	1135	1263	1362						
120	330	366	407	451	501	555	616	696	772	856	973	1071	1157	1283	1414							
126	336	374	415	462	509	566	627	708	787	874	993	1092	1182	1312	1432							
132	345	382	424	470	521	579	641	722	803	891	1012	1114	1204	1338								
138	352	388	431	479	531	591	654	738	819	909	1033	1136	1229	1359								
144	357	395	439	490	541	602	667	752	835	925	1053	1159	1254	1413								

Color Lux Linen Blackout: Minimum standard shade size is 12" x 12". Maximum shade width is 106" and it can be railroaded to a maximum width of 144" and a maximum length of 108"

Head Rail Options and Surcharges

Section 1 & 2	Available: Skyline Hardware (All), Designer Cassette (All), Cordless Deco-Bar, 4" Skyline Fascia, Motorization, PowerTouch Rechargeable
Section 3	Available: Skyline Roller Only with Cordloop, Heavy Duty Motorization (Roller Only), 4" Skyline Fascia with Cord Loop (Dual Roller Not Available)
Section 4	Available: Skyline Roller Only with Cordloop, and Heavy Duty Motorization (Roller Only) (Dual Roller Not Available)

Skyline Clutch Surcharge

White, Ivory and Black	No Charge
Satin Nickel and Bronze	Add \$27 to standard rectangular price

Designer Cassette 24 30 36 42 48 54 60 66 72 78 84 90 96 102 108 114 120

White, Ivory, Black, Brushed Nickel and Oil Rubbed Bronze Includes Smooth, Fabric Wrap and Insert Strip Option	74	80	86	92	98	106	113	120	127	122	129	140	145	149	154	176	198
---	----	----	----	----	----	-----	-----	-----	-----	-----	-----	-----	-----	-----	-----	-----	-----

4" Skyline Fascia 24 30 36 42 48 54 60 66 72 78 84 90 96 102 108 114 120

White, Ivory, Black, Brushed Nickel and Oil Rubbed Bronze 4" Skyline Fascia	61	67	69	70	80	92	101	111	122	130	142	154	161	170	182	191	200
--	----	----	----	----	----	----	-----	-----	-----	-----	-----	-----	-----	-----	-----	-----	-----

Cordless Roller

Cordless with Deco-Bar*	Add \$40
Cordless with Cassette	Add \$40 PLUS the Designer Cassette Surcharge to Standard Rectangular Price

*Minimum width is 15½"; Maximum Width is 90"; Maximum Length is 84"

Retractable Cord with Designer Cassette

White and Black Retractable Cord	Add \$40 PLUS the Designer Cassette Surcharge to Standard Rectangular Price
----------------------------------	---

Dual Roller Shades

White and Black Brackets	Price as two separate roller shades with desired options. Add \$27 to total.
--------------------------	--

Two on One Head Rail: Price as two separate roller shades with Designer Cassette option and add together.

Highlights Cornice Valance 24 30 36 42 48 54 60 66 72 78 84 94 102 106 112 118 124 130 136 144

Highlights Cornice Valance (No Keystone)	91	101	110	119	130	136	143	150	156	162	169	180	Requires keystone. See pricing below							
Highlights Cornice Valance (with Keystone)	122	132	142	150	161	167	174	181	187	193	200	211	227	234	242	251	259	269	278	288

Highlights Valance with Keystone: All valances made over 94" wide will require a keystone (shaded area).

Scotchgard™ Stain Protection

Scotchgard™ Stain Protection	Add \$35 to the standard rectangular price
------------------------------	--

Bottom Rail Tassel Pulls: See page 86 for pricing and details.

Motorization: See pages 89 - 95 for all motorization options.

NEW Simplicity Wave for Roller: See pages 76 & 89 for more information.

NEW Solar Panel Option for Simplicity Rechargeable Shades with Remote: See page 95.

NEW Heavy Duty Roller Motors: See page 91 for more information.

Tube Information for Clutch Operated Shades Only

- **Section 1:** Shades to the left of the dashed line requires a 1" tube/SL10" clutch
- **Section 2:** Shades to the right of the dashed line requires a 1½" tube/SL10 clutch
- **Section 3:** Shades in the blue section requires a 2" tube/SL20 clutch.
- **Section 4:** Shades in the orange section requires a 2½" tube/ Galaxy 200 clutch

Skyline Standard Roller Shade

Price Group 21 | Solar Screen 5

Length In Inches	Width In Inches																					
	24	30	36	42	48	54	60	66	72	78	84	90	96	102	106	112	118	124	130	136	144	
36	215	239	265	294	327	362	403	454	504	560	637	702	756	817	881	901	1073	1171	1278	1397	1524	
42	220	245	272	303	336	373	413	467	519	575	653	719	776	839	906	923	1102	1202	1315	1433	1567	
48	227	252	280	311	345	384	424	478	532	590	671	738	797	861	930	948	1131	1234	1348	1472	1606	
54	235	258	286	318	353	391	436	491	545	604	689	756	819	884	954	974	1160	1266	1381	1509	1649	
60	239	265	294	326	362	402	446	504	560	621	705	775	837	904	976	995	1188	1297	1418	1546	1667	
66	245	271	302	334	372	412	457	514	572	635	721	795	857	926	1001	1022	1218	1329	1450	1585	1690	
72	250	279	308	344	380	421	468	528	587	650	740	812	879	948	1026	1045	1247	1362	1484	1623	1715	
78	257	284	317	350	388	431	478	541	599	667	756	831	898	971	1047	1070	1276	1392	1520	1630	1732	
84	262	291	322	357	397	442	491	551	614	680	774	852	920	993	1071	1093	1304	1424	1467	1635	1743	
90	269	297	330	366	407	451	500	565	627	696	790	869	940	1033	1106	1118	1333	1456	1500	1649	1757	
96	274	304	337	376	416	460	510	578	639	710	808	890	960	1077	1133	1142	1363	1487	1532	1666	1783	
102	280	311	344	382	423	471	523	590	655	726	826	908	980	1105	1156	1156	1217	1453	1585	1633	1776	1901
108	285	317	352	389	434	480	533	601	669	741	842	926	1001	1111	1193	1193	1297	1549	1690	1741	1893	2027
114	291	322	357	397	442	491	544	614	682	756	861	945	1023	1137	1228							
120	297	330	366	407	451	500	555	626	696	771	877	965	1042	1156	1274							
126	303	336	374	416	459	510	565	638	709	787	894	983	1065	1182	1291							
132	311	344	382	423	469	522	578	651	723	803	912	1003	1085	1206	1363							
138	317	350	388	432	478	532	589	664	738	819	930	1024	1106	1224	1387							
144	322	356	395	441	487	542	600	678	752	833	948	1044	1130	1273	1414							

Solar Screen 5: Minimum standard shade size is 12" x 12". Maximum shade width is 114" and it can be railroaded to a maximum width of 144" and a maximum length of 108".

Head Rail Options and Surcharges

Section 1 & 2	Available: Skyline Hardware (All), Designer Cassette (All), Cordless Deco-Bar, 4" Skyline Fascia, Motorization, PowerTouch Rechargeable
Section 3	Available: Skyline Roller Only with Cordloop, Heavy Duty Motorization (Roller Only), 4" Skyline Fascia with Cord Loop (Dual Roller Not Available)
Section 4	Available: Skyline Roller Only with Cordloop, and Heavy Duty Motorization (Roller Only) (Dual Roller Not Available)

Skyline Clutch Surcharge

White, Ivory and Black	No Charge
Satin Nickel and Bronze	Add \$27 to standard rectangular price

Designer Cassette 24 30 36 42 48 54 60 66 72 78 84 90 96 102 108 114 120

White, Ivory, Black, Brushed Nickel and Oil Rubbed Bronze Includes Smooth and Insert Strip Option	74	80	86	92	98	106	113	120	127	122	129	140	145	149	154	176	198
--	----	----	----	----	----	-----	-----	-----	-----	-----	-----	-----	-----	-----	-----	-----	-----

Fabric Wrapped Designer Cassette is not available with Solar Screen 5

4" Skyline Fascia 24 30 36 42 48 54 60 66 72 78 84 90 96 102 108 114 120

White, Ivory, Black, Brushed Nickel and Oil Rubbed Bronze 4" Skyline Fascia	61	67	69	70	80	92	101	111	122	130	142	154	161	170	182	191	200
--	----	----	----	----	----	----	-----	-----	-----	-----	-----	-----	-----	-----	-----	-----	-----

Cordless Roller

Cordless with Deco-Bar*	Add \$40
Cordless with Cassette	Add \$40 PLUS the Designer Cassette Surcharge to Standard Rectangular Price

*Minimum width is 15½", Maximum width is 96", Maximum length is 96"

Retractable Cord with Designer Cassette

White and Black Retractable Cord	Add \$40 PLUS the Designer Cassette Surcharge to Standard Rectangular Price
----------------------------------	---

Dual Roller Shades

White and Black Brackets	Price as two separate roller shades with desired options. Add \$27 to total.
--------------------------	--

Two on One Head Rail: Price as two separate roller shades with Designer Cassette option and add together.

Highlights Cornice Valance 24 30 36 42 48 54 60 66 72 78 84 94 102 106 112 118 124 130 136 144

Highlights Cornice Valance (No Keystone)	91	101	110	119	130	136	143	150	156	162	169	180	Requires keystone. See pricing below							
Highlights Cornice Valance (with Keystone)	122	132	142	150	161	167	174	181	187	193	200	211	227	234	242	251	259	269	278	288

Highlights Valance with Keystone: All valances made over 94" wide will require a keystone (shaded area).

Scotchgard™ Stain Protection

Scotchgard™ Stain Protection	Add \$35 to the standard rectangular price
------------------------------	--

Bottom Rail Tassel Pulls: See page 86 for pricing and details.

Motorization: See pages 89 - 95 for all motorization options.

NEW Simplicity Wave for Roller: See pages 76 & 89 for more information.

NEW Solar Panel Option for Simplicity Rechargeable Shades with Remote: See page 95.

NEW Heavy Duty Roller Motors: See page 91 for more information.

Tube Information for Clutch Operated Shades Only

- Section 1: Shades to the left of the dashed line requires a 1" tube/SL10" clutch
- Section 2: Shades to the right of the dashed line requires a 1½" tube/SL10 clutch
- Section 3: Shades in the blue section requires a 2" tube/SL20 clutch.
- Section 4: Shades in the orange section requires a 2½" tube/ Galaxy 200 clutch

COLOR LUX® ROLLER SHADES

Color Lux® Roller Shade Fabric Information

Choosing the Right Color Lux Roller Fabric

What are the fabric contents of each fabric?

- Classic Duck Light Filtering is 100% Polyester
- Classic Duck Blackout is 100% Polyester
- Linen Light Filtering is 100% Polyester
- Linen Blackout is 100% Polyester with a foam coated backing
- Solar Screen 5 is 36% Polyester, 51% FR Polyester and 13% Cationic Polyester

Classic Duck Light Filtering and Blackout Fabrics

Classic Duck provides the perfect canvas for all 800 Color Lux colors. A simple weave works well with any complementary fabric textures. Available in Light Filtering and Blackout.

Linen Light Filtering and Blackout Fabrics

Linen provides the natural timeless look of linen fabric into Color Lux Roller Shades. Light Filtering allows in just the right amount of opacity to maintain privacy but allow light into the home. Linen Blackout is perfect for bedroom and media room applications.

Solar Screen 5 Fabric

Solar Screen 5 is the perfect balance of function and design. With a 5% openness factor, Solar Screen 5 provides light and privacy. Color Lux Color 100 Ultra White has passed the NFPA and California Title 19 Fire Rating Standards. Solar Screen 5 also offers a subtle linen texture that enhances every decor style.

What are the fabric properties of Solar Screen 5?

The below ratings apply to **Color Lux Color 100 Ultra White Only**

	TS	RS	AS	TV	OF	SHGC/G Value		Fire Rating
						Commercial SHGC % Improvement	Residential SHGC	
Solar Screen 5								
100 Ultra White*	39	56	5	38	5.00	39%	0.42	NFPA 701-10 TM#1, California U.S. Title 19
ISO 14001:2004 OEKO-TEX® Standard 100 OEKO-TEX® Standard 1000 Zero Landfill Water Conservation and Usage Use of Recycled Materials								

* Fire Rating and other properties apply to Ultra White (Color Lux Color 100) only

To be certified with OEKO-TEX® Standard 100, companies have to meet defined criteria regarding their environmentally friendly and socially acceptable production process at all production stages (International Association for Research and Testing in the Field of Textile Ecology)

- TS = Solar Transmittance
- RS = Solar Reflectance
- AS = Solar Absorbance
- TV = Visual Transmittance
- OF = Openness Factor
- 1/4 CL = 1/4" Clear Glass
- 1/4 HA = 1/4" Heat Absorbing Glass

Color Lux® Roller Shade Head Rail Options

Skyline Standard Roller Shades

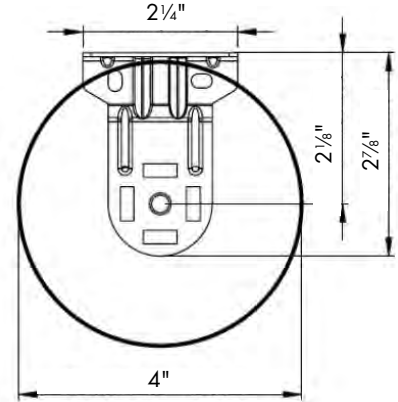
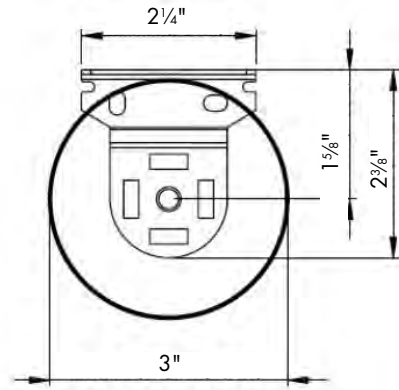

Hardware Features

Roll Style:	Standard or reverse (reverse roll information is found on page 88)
Bead Chain Color:	White, Black, Ivory, Satin Nickel and Bronze
Clutch Color:	White, Black, Ivory, Satin Nickel and Bronze
Bracket Cover Colors:	White, Black, Ivory, Satin Nickel and Bronze (Heavy Duty Motorization does not offer bracket covers)
Bracket Colors:	White, Black, Ivory and Bronze (Heavy Duty Motorization Brackets are white only)
Bottom Rail Style:	Fabric Wrapped or Exposed Bottom Rail
Bottom Rail Color:	Fabric Wrapped: White, Black, Ivory, Brushed Aluminum and Bronze Exposed: White, Black, Ivory, Brushed Aluminum and Bronze
Motorization	Skyline Standard Roller Hardware can be motorized with Simplicity Motorization (non-rechargeable or rechargeable) or PowerTouch™ Rechargeable. See grids for pricing and pages 89 - 95 for details.

Mounting Dimensions

The standard 1" and 1 1/2" tubes are available with two brackets in 2 3/8" or 2 7/8" projection.

Minimum depth for flush inside or side mount including installation brackets: 2 1/4"

The oversized 2" tube is available with one bracket in a 2 7/8" projection.

Minimum depth for flush inside mount including installation brackets: 2 1/4"

Standard Roller Finished Dimensions	Standard Tube Cord Loop (1" & 1 1/2" diameter)	Standard Tube Motorized (1 1/2" diameter)	Oversized Tube Cord Loop (2" diameter)	Oversized Tube Cord Loop (2 1/2" diameter)	Oversized Tube Motorization (2" & 2 1/2" diameter)
Inside Mount (+/- 1/8")					
Bracket to Bracket:	Ordered width	Ordered width	Ordered width	Ordered width	Ordered width minus 3/16"
End to End Roller Width:	Ordered width minus 1"	Ordered width minus 1 1/8"	Ordered width minus 1 1/16"	Ordered width minus 1 1/4"	Ordered width minus 2 3/16"
Fabric Width:	Ordered width minus 1 1/16"	Ordered width minus 1 3/16"	Ordered width minus 1 1/8"	Ordered width minus 1 5/16"	Ordered width minus 2 1/4"
Bottom Rail Width:	Ordered width minus 1 1/16"	Ordered width minus 1 3/16"	Ordered width minus 1 1/8"	Ordered width minus 1 5/16"	Ordered width minus 2 1/4"
Outside Mount and Inside Mount with Bracket Covers (+/- 1/8")					
End Cap Cover to End Cap Cover:	Ordered width	Ordered width	Ordered width	Ordered width	N/A
Bracket to Bracket:	Ordered width minus 1/8"	Ordered width minus 1/4"	Ordered width minus 1/8"	Ordered width minus 1 1/8"	Ordered width minus 3/16"
End to End Roller Width:	Ordered width minus 1 1/8"	Ordered width minus 1 1/4"	Ordered width minus 1 3/16"	Ordered width minus 1 3/8"	Ordered width minus 1 13/16"
Fabric Width:	Ordered width minus 1 3/16"	Ordered width minus 1 5/16"	Ordered width minus 1 1/4"	Ordered width minus 1 7/16"	Ordered width minus 1 7/8"
Bottom Rail Width:	Ordered width minus 1 3/16"	Ordered width minus 1 5/16"	Ordered width minus 1 1/4"	Ordered width minus 1 7/16"	Ordered width minus 1 7/8"

COLOR LUX® ROLLER SHADES

Color Lux® Roller Shade Head Rail Options

Cordless Roller with Deco-Bar Mounting Rail



Shades Measuring 15½" to 72":

- A = 1½"
- B = 1⅝"
- C = 2¼"
- D = 1¼" Roller

Shades Measuring 72" to Maximum Width:

- A = 1¾"
- B = 1¾"
- C = 2¾"
- D = 1½" Roller

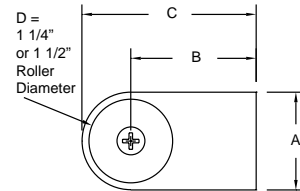
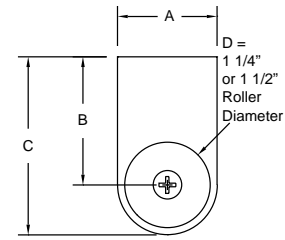

Head Rail Consistency

Cordless Roller with Deco-Bar Shades under 72" wide utilize a 1¼" roller and shades over 72" wide utilize a 1½" roller. If an order has multiple shades with varying widths, be aware of potential tube inconsistencies. Fabric will add an average of ⅛" to the diameter of the tube for every 10" of fabric rolled onto the tube. Contact Technical Services if additional services is needed.

Hardware Features

Roll Style:	Standard or reverse (reverse roll information is found on page 88)
Hardware Color:	White, Ivory, Black, Satin Nickel and Bronze (brackets are white or black)
Bracket Covers:	White, Ivory, Black, Satin Nickel and Bronze
Bottom Rail Style:	Fabric Wrapped or Exposed Bottom Rail
Bottom Rail Color:	Fabric Wrapped: White, vanilla, bronze, black or brushed aluminum Exposed: White, vanilla, bronze, black or brushed aluminum
Motorization	Cordless Roller with Deco-Bar cannot be motorized.
Head Rail Surcharge	See price grids for Cordless surcharge information.

Mounting Dimensions

Minimum depth for flush inside mount including installation brackets: 1¾"

Minimum inside mounting height: 1¼"

Minimum outside mounting height: 1"

Cordless Roller with Deco-Bar Finished Dimensions (+/- ⅛")

Inside Mount

Head Rail Measurement: Ordered width minus ⅜" (measurement includes end brackets)

Fabric Width: Ordered width minus 1⅜"

Inside Mount with Bracket Covers

Head Rail Measurement: Ordered width minus 7/16"

Fabric Width: Ordered width minus 1 1/16"

Outside Mount

Head Rail Measurement: Ordered width plus ⅜" (measurement includes end brackets)

Fabric Width: Ordered width minus 7/16"

Side Mount

Head Rail Measurement: Ordered width minus 1 1/16" (measurement includes end brackets)

Fabric Width: Ordered width minus 1 5/16"

Exact End to End Mount

Head Rail Measurement: Ordered width (measurement includes end brackets)

Fabric Width: Ordered width minus 5/8"

Color Lux® Roller Shade Head Rail Options Designer Cassette with Insert Strip

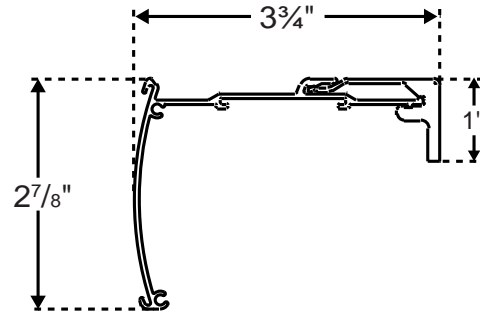

COLOR LUX® ROLLER SHADES

Hardware Features

Roll Style:	Standard only
Head Rail Color:	White, Ivory, Black, Satin Nickel and Bronze with matching fabric insert strip Skyline Clutch is available in White, Ivory, Black, Satin Nickel and Bronze
Bottom Rail Style:	Fabric Wrapped or Exposed Bottom Rail
Bottom Rail Color:	Fabric Wrapped: White, vanilla, bronze, black or brushed aluminum Exposed: White, vanilla, bronze, black or brushed aluminum
Bead Chain Color:	White, ivory, black, bronze or steel bead chain
Operation Options:	Cord Loop: Select bead chain color, bottom rail style and color Cordless: Select bottom rail style and color
Motorization	Designer Cassette can be motorized with Simplicity Motorization (non-rechargeable or rechargeable) or PowerTouch™ Rechargeable. See grids for pricing and pages 89 - 95 for motorization details.
Cassette Surcharge	See price grids for surcharge information.

Mounting Dimensions

Minimum depth for flush inside mount including installation brackets:	3 3/4"
Minimum depth required for shallow mounting:	1"
Minimum depth for side mount:	1 1/8" • Maximum shade width for side mount: 48"
Minimum height required for outside mounting:	1"

Designer Cassette Finished Head Rail Measurements for Cord Loop, Cordless and Motorized Shades (+/- 1/8")

Inside Mount	
Head Rail Measurement:	Ordered width minus 3/16" (measurement includes end caps)
Outside Mount	
Head Rail Measurement:	Ordered width plus 3/16" (measurement includes end caps)
Side Mount	
Head Rail Measurement:	Ordered width minus 1 1/16" (measurement includes end caps)
Exact End to End Mount	
Head Rail Measurement:	Ordered width (measurement includes end caps)

Designer Cassette Finished Fabric Measurements (+/- 1/8")

Mount	Cord Loop & Motorized	Cordless	Skyline Cord Loop
Inside Mount:	Ordered width minus 1 1/16"	Ordered width minus 1"	Ordered width minus 1 1/4"
Outside Mount:	Ordered width minus 1 1/16"	Ordered width minus 5/8"	Ordered width minus 7/8"
Side Mount:	Ordered width minus 1 9/16"	Ordered width minus 1 1/2"	Ordered width minus 1 3/4"
Exact End to End Mount:	Ordered width minus 7/8"	Ordered width minus 1 3/16"	Ordered width minus 1 1/16"

Color Lux® Roller Shade Head Rail Options

Designer Cassette with Fabric Wrap

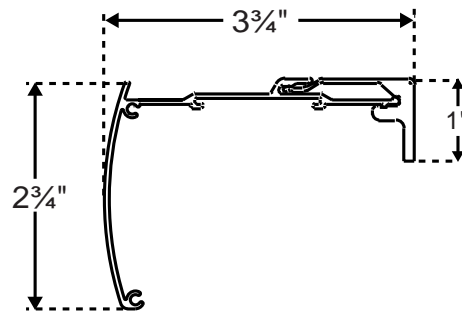

Hardware Features	
Roll Style:	Standard only
Head Rail Color:	White, Ivory, Black, Satin Nickel and Bronze with Fabric Wrap Skyline Clutch is available in White, Ivory, Black, Satin Nickel and Bronze
Bottom Rail Style:	Fabric Wrapped or Exposed Bottom Rail
Bottom Rail Color:	Fabric Wrapped: White, vanilla, bronze, black or brushed aluminum Exposed: White, vanilla, bronze, black or brushed aluminum
Bead Chain Color:	White, black, bronze or steel bead chain
Operation Options:	Cord Loop: Select bead chain color, bottom rail style and color Cordless: Select bottom rail style and color
Motorization	Designer Cassette can be motorized with Simplicity Motorization (non-rechargeable or rechargeable) or PowerTouch™ Rechargeable. See grids for pricing and pages 89 - 95 for motorization details.
Cassette Surcharge	See price grids for surcharge information.

Mounting Dimensions	
Minimum depth for flush inside mount including installation brackets: 3 3/4"	
Minimum depth required for shallow mounting: 1"	
Minimum depth for side mount: 1 1/8" • Maximum shade width for side mount: 48"	
Minimum height required for outside mounting: 1"	

Designer Cassette Finished Head Rail Measurements for Cord Loop, Cordless and Motorized Shades (+/- 1/8")

Inside Mount	
Head Rail Measurement:	Ordered width minus 3/16" (measurement includes end caps)
Outside Mount	
Head Rail Measurement:	Ordered width plus 3/16" (measurement includes end caps)
Side Mount	
Head Rail Measurement:	Ordered width minus 1 1/16" (measurement includes end caps)
Exact End to End Mount	
Head Rail Measurement:	Ordered width (measurement includes end caps)

Designer Cassette Finished Fabric Measurements (+/- 1/8")			
Mount	Cord Loop & Motorized	Cordless	Skyline Cord Loop
Inside Mount:	Ordered width minus 1 1/16"	Ordered width minus 1"	Ordered width minus 1 1/4"
Outside Mount:	Ordered width minus 1 1/16"	Ordered width minus 5/8"	Ordered width minus 7/8"
Side Mount:	Ordered width minus 1 9/16"	Ordered width minus 1 1/2"	Ordered width minus 3/4"
Exact End to End Mount:	Ordered width minus 7/8"	Ordered width minus 13/16"	Ordered width minus 1 1/16"

COLOR LUX® ROLLER SHADES

Color Lux® Roller Shade Head Rail Options Designer Cassette with Smooth Face

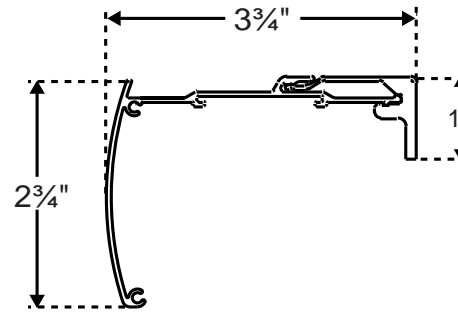

COLOR LUX® ROLLER SHADES

Hardware Features

Roll Style:	Standard only
Head Rail Color:	White, Ivory, Black, Satin Nickel and Bronze Skyline Clutch is available in White, Ivory, Black, Satin Nickel and Bronze
Bottom Rail Style:	Fabric Wrapped or Exposed Bottom Rail
Bottom Rail Color:	Fabric Wrapped: White, vanilla, bronze, black or brushed aluminum Exposed: White, vanilla, bronze, black or brushed aluminum
Bead Chain Color:	White, black, bronze or steel bead chain
Operation Options:	Cord Loop: Select bead chain color, bottom rail style and color Cordless: Select bottom rail style and color
Motorization	Designer Cassette can be motorized with Simplicity Motorization (non-rechargeable or rechargeable) or PowerTouch™ Rechargeable. See grids for pricing and pages 89 - 95 for motorization details.
Cassette Surcharge	See price grids for surcharge information.

Mounting Dimensions

Minimum depth for flush inside mount including installation brackets: 3 3/4"
Minimum depth required for shallow mounting: 1"
Minimum depth for side mount: 1 1/8" • Maximum shade width for side mount: 48"
Minimum height required for outside mounting: 1"

Designer Cassette Finished Head Rail Measurements for Cord Loop, Cordless and Motorized Shades (+/- 1/8")

Inside Mount	
Head Rail Measurement:	Ordered width minus 3/16" (measurement includes end caps)
Outside Mount	
Head Rail Measurement:	Ordered width plus 3/16" (measurement includes end caps)
Side Mount	
Head Rail Measurement:	Ordered width minus 1 1/16" (measurement includes end caps)
Exact End to End Mount	
Head Rail Measurement:	Ordered width (measurement includes end caps)

Designer Cassette Finished Fabric Measurements (+/- 1/8")

Mount	Cord Loop & Motorized	Cordless	Skyline Cord Loop
Inside Mount:	Ordered width minus 1 1/16"	Ordered width minus 1"	Ordered width minus 1 1/4"
Outside Mount:	Ordered width minus 1 1/16"	Ordered width minus 5/8"	Ordered width minus 7/8"
Side Mount:	Ordered width minus 1 9/16"	Ordered width minus 1 1/2"	Ordered width minus 1 3/4"
Exact End to End Mount:	Ordered width minus 7/8"	Ordered width minus 1 3/16"	Ordered width minus 1 1/16"

Color Lux® Roller Shade Head Rail Options Designer Cassette with Retractable Cord

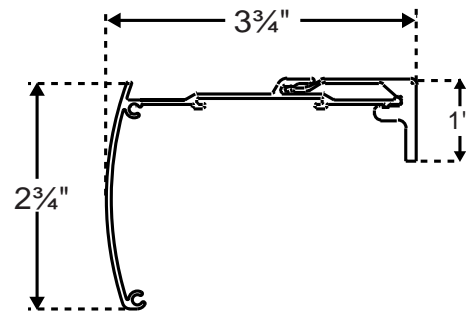

Hardware Features

Roll Style:	Standard only
Head Rail Color:	White, Ivory, Black, Satin Nickel and Bronze Retractable Cord Clutch is available in White and Black only
Bottom Rail Style:	Fabric Wrapped or Exposed Bottom Rail
Bottom Rail Color:	Fabric Wrapped: White, vanilla, bronze, black or brushed aluminum Exposed: White, vanilla, bronze, black or brushed aluminum
Cord Color:	White or Black Cord and Tassel to coordinate with clutch
Cassette Surcharge	See price grids for surcharge information.

Mounting Dimensions

Minimum depth for flush inside mount including installation brackets: 3 3/4"
Minimum depth required for shallow mounting: 1"
Minimum depth for side mount: 1 1/8" • Maximum shade width for side mount: 48"
Minimum height required for outside mounting: 1"

Designer Cassette Finished Head Rail Measurements for Retractable Cord (+/- 1/8")

Inside Mount	
Head Rail Measurement:	Ordered width minus 3/16" (measurement includes end caps)
Outside Mount	
Head Rail Measurement:	Ordered width plus 3/16" (measurement includes end caps)
Side Mount	
Head Rail Measurement:	Ordered width minus 1 1/16" (measurement includes end caps)
Exact End to End Mount	
Head Rail Measurement:	Ordered width (measurement includes end caps)

Designer Cassette Finished Fabric Measurements (+/- 1/8")

Mount	Retractable Cord
Inside Mount:	Ordered width minus 1 7/16"
Outside Mount:	Ordered width minus 1 1/16"
Side Mount:	Ordered width minus 1 5/16"
Exact End to End Mount:	Ordered width minus 1 1/4"

Color Lux® Roller Shade Head Rail Options Designer Cassette with Simplicity Wave

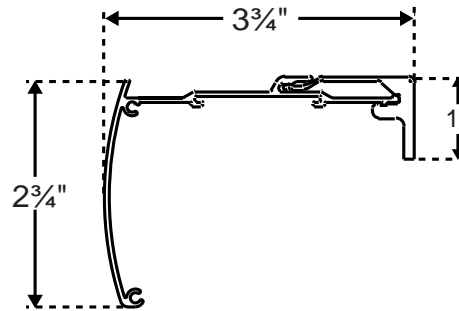

COLOR LUX® ROLLER SHADES

Hardware Features	
Roll Style:	Standard only
Head Rail Color:	White, Ivory, Black, Satin Nickel and Bronze Simplicity Wave is available with smooth face, fabric wrapped and insert strip Designer Cassette
Bottom Rail Style:	Fabric Wrapped or Exposed Bottom Rail
Bottom Rail Color:	Fabric Wrapped: White, vanilla, bronze, black or brushed aluminum Exposed: White, vanilla, bronze, black or brushed aluminum
Bead Chain Color:	White, black, bronze or steel bead chain
Motorization	See page 89 for pricing and more information on Simplicity Wave Motorization.
Cassette Surcharge	See price grids for surcharge information.

Mounting Dimensions	
Minimum depth for flush inside mount including installation brackets:	3 3/4"
Minimum depth required for shallow mounting:	1"
Minimum depth for side mount:	1 1/8" • Maximum shade width for side mount: 48"
Minimum height required for outside mounting:	1"

Designer Cassette Finished Head Rail Measurements for Cord Loop, Cordless and Motorized Shades (+/- 1/8")

Inside Mount	
Head Rail Measurement:	Ordered width minus 3/16" (measurement includes end caps)
Outside Mount	
Head Rail Measurement:	Ordered width plus 3/16" (measurement includes end caps)
Side Mount	
Head Rail Measurement:	Ordered width minus 1 1/16" (measurement includes end caps)
Exact End to End Mount	
Head Rail Measurement:	Ordered width (measurement includes end caps)

Designer Cassette Finished Fabric Measurements (+/- 1/8")	
Mount	Simplicity Wave Motorization
Inside Mount:	Ordered width minus 1 1/16"
Outside Mount:	Ordered width minus 1 1/16"
Side Mount:	Ordered width minus 1 3/16"
Exact End to End Mount:	Ordered width minus 7/8"

Color Lux® Roller Shade Head Rail Options

4" Skyline Fascia with Cord Loop and Simplicity Motorization

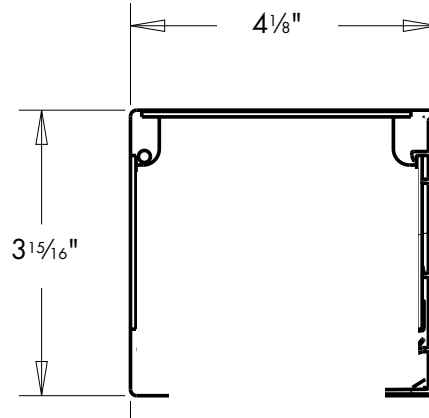

Hardware Features	
Fascia Colors:	White, Ivory, Black, Satin Nickel and Bronze
Roll Style:	Standard only
Bead Cord Style and Color:	White, Ivory, Black, Satin Nickel and Bronze
Skyline Clutch Colors:	White, Ivory, Black, Satin Nickel and Bronze
Bottom Rail Style:	Fabric Wrapped or Exposed Bottom Rail
Bottom Rail Color:	Fabric Wrapped: White, Black, Vanilla, Brushed Aluminum and Bronze Exposed: White, Black, Vanilla, Brushed Aluminum and Bronze
Tensioner Color:	White, Ivory, Black, Satin Nickel and Bronze
Motorization	4" Skyline Fascia can be motorized with Simplicity Motorization (non-rechargeable or rechargeable) or PowerTouch™ Rechargeable. See grids for pricing and pages 89 - 95 for motorization details.
Mounting Dimensions	
Minimum depth for flush inside mount including installation brackets: 4 1/8"	
Minimum surface height required for outside mount: 4"	
4" Inch Skyline Fascia can be installed as an inside mount with bracket covers.	

Standard Roller Finished Dimensions (+/- 1/8")	Standard Tube (1" and 1 1/2" diameter)	Oversized Tube (2" diameter)
Inside Mount		
Bracket to Bracket Measurement:	Ordered width	Ordered width
End to End Roller Width:	Ordered width minus 1"	Ordered width minus 1 1/16"
Fabric Width:	Ordered width minus 1 1/16"	Ordered width minus 1 1/8"
Bottom Rail Width:	Ordered width minus 1 1/16"	Ordered width minus 1 1/8"
Outside Mount and Exact Mount		
End Cap Cover to End Cap Cover:	Ordered width	Ordered width
Bracket to Bracket Measurement:	Ordered width minus 1/8"	Ordered width minus 1/8"
End to End Roller Width:	Ordered width minus 1 1/8"	Ordered width minus 1 3/16"
Fabric Width:	Ordered width minus 1 3/16"	Ordered width minus 1 1/4"
Bottom Rail Width:	Ordered width minus 1 3/16"	Ordered width minus 1 1/4"

COLOR LUX® ROLLER SHADES

Color Lux® Roller Shade Head Rail Options

Dual Roller Shades with Cordloop and Simplicity Rechargeable Motorization

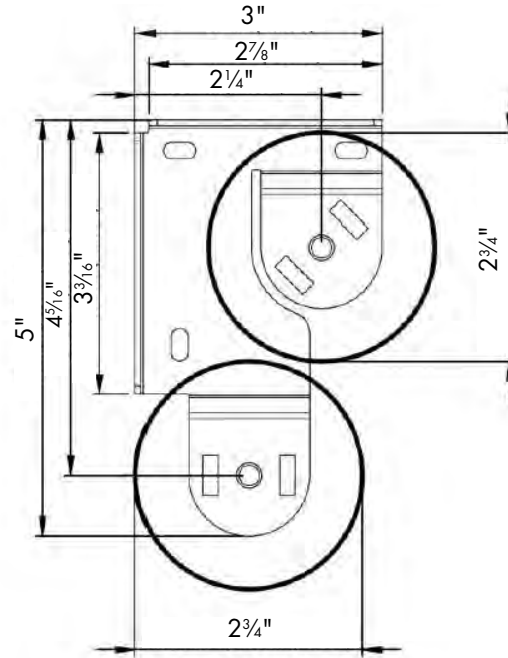

COLOR LUX® ROLLER SHADES

Hardware Features	
Roll Style:	Standard and reverse roll is required (reverse roll information is found on page 88)
Bead Chain Color:	White, Ivory, Black, Satin Nickel and Bronze
Clutch Color:	White, Ivory, Black, Satin Nickel and Bronze (Skyline Hardware Only)
Bracket Cover Colors:	Bracket Covers are Not Available
Bracket Colors:	White and Black
Bottom Rail Style:	Fabric Wrapped or Exposed Bottom Rail
Bottom Rail Color:	Fabric Wrapped: White, Black, Ivory, Brushed Aluminum and Bronze Exposed: White, Black, Ivory, Brushed Aluminum and Bronze
Tensioner Colors:	White, Ivory, Black, Satin Nickel and Bronze
Motorization	Standard Roller Hardware can be motorized with Simplicity Rechargeable Motorization (non-rechargeable not available.) PowerTouch Rechargeable is not available with Dual Roller Shades. See page 89 - 95 for motorization details.

Mounting Dimensions	
Minimum depth for flush inside mount including installation brackets: 3"	
Minimum depth required for side mounting: 1"	

Standard Roller Finished Dimensions (+/- 1/8")	Standard Tube (1" and 1 1/2" diameter)	Oversized Tube (2" diameter)
Inside Mount and Outside Mount		
Bracket to Bracket Measurement:	Ordered width	Ordered width
End to End Roller Width:	Ordered width minus 1"	Ordered width minus 1 1/16"
Fabric Width:	Ordered width minus 1 1/16"	Ordered width minus 1 1/8"
Bottom Rail Width:	Ordered width minus 1 1/16"	Ordered width minus 1 1/8"

Color Lux® Highlights Cornice Valance with Keystone



Highlight any element of your home décor with the Highlights Cornice Valance upgrade. This tailored, fabric wrapped 6-inch valance, available with seven returns sized from 1½" to 6", mounts over any product, either inside or outside the frame. The keystone option now allows for all fabrics to cover widths up to 216". It's the perfect solution for our Panel Track system. Highlights Valance without a keystone can be added to your roller shade order or as a stand alone product. Highlights Valance orders with a keystone are a stand alone product only.

Width In Inches

	24	30	36	42	48	54	60	66	72	78	84	94	102	106	112	118	124	130	136	144	150	156	162	168	174	180	186	192	198	204	210	216
Highlights Cornice Valance (No Keystone)	91	101	110	119	130	136	143	150	156	162	169	180	Keystone is required after 94". See pricing below to add a keystone.																			
Highlights Cornice Valance (with Keystone)	122	132	142	150	161	167	174	181	187	193	200	211	227	234	242	251	259	269	278	288	297	305	314	324	334	343	354	365	408	418	432	442

Highlights Valance Specifications

Valance Width with Keystone: Maximum valance width is 216" for all Color Lux Roller Fabrics.

- Fabric cannot be railroaded
- Seaming is not available.
- Multiple Keystones may be required for larger widths. (ex. 216" Highlights Valance will require TWO Keystones, each 72" wide).

Valance Height: 6"

Standard Return Sizes:

- Inside Mount: None
- Outside Mount ordered with shade: 4"
- Custom Stand Alone Valance: Seven sizes are available, see chart below.

Highlights Cornice Valance Upgrade can be ordered in three ways:

- Inside Mount WITH your shade
- Outside Mount WITH your shade
- Custom Stand Alone Valance with seven return sizes

Highlights Ordering and Measuring Instructions Inside Mount Valance WITH Your Shade

- Inside mount valances are made without returns.
- An inside mount Highlights Valance will come with its own set of mounting brackets. In most scenarios, the valance brackets must be installed separately from the shade.
- Measure the inside width at the top of the window where the valance is to be installed. Measure in multiple spots to ensure accuracy. If there are variances, supply the smallest measurement.
- Please Note: The finished dimension of your inside mount bracket will be 3/16" less than your ordered width (see Figure A). Example: An inside mount valance ordered at 36" wide will be made 35 13/16".
- Please Note: You will need up to 3 1/2" of mounting depth to ensure your valance is fully recessed and flush with your window opening.

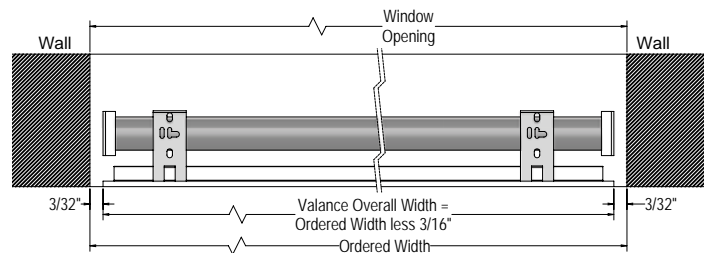

Figure A

Mounting Information with Stand Alone Highlight Valances with Returns Size Options

Style	Return Size	Mounting Depth Required	Inside Valance Depth Clearance Provided	Comments
Inside Mount	None	3" for flush	N/A	Mounted inside window opening
Shallow Mount	1 ½"	1 ½"	7/8"	Outside Mount valance with bracket mounted inside window opening
Shallow Mount	2"	1"	1 3/8"	Outside Mount valance with bracket mounted inside window opening
Shallow Mount	2 ½"	½"	1 7/8"	Outside Mount valance with bracket mounted inside window opening
Outside Mount	3"	½" surface height	2 3/8"	Valance will be mounted outside window opening
Outside Mount	4"	½" surface height	3 3/8"	Valance will be mounted outside window opening
Outside Mount	5"	½" surface height	4 3/8"	Valance will be mounted outside window opening
Outside Mount	6"	½" surface height	5 3/8"	Valance will be mounted outside window opening

Color Lux® Highlights Cornice Valance with Keystone

Highlights Ordering and Measuring Instructions

Outside Mount Valance WITH Your Shade

- Outside mount valance will have 4" returns.
- An outside mount Highlights Valance will come with its own set of mounting brackets. In most scenarios, the valance brackets must be installed separately from the shade.
- Measure the width of the area you wish to cover. Be sure to add extra space if you have window trim or extra wall space you'd like to cover.
- **Please Note:** When ordering outside mount valances, the finished overall width of your valance will be your ordered width plus 1 1/4" (see Figures B and C).
- **Example:** An outside mount valance ordered at 36" wide will be made 37 1/4".
- **Please Note:** You will need 1/2" of surface area to mount your valance (see Figure B).

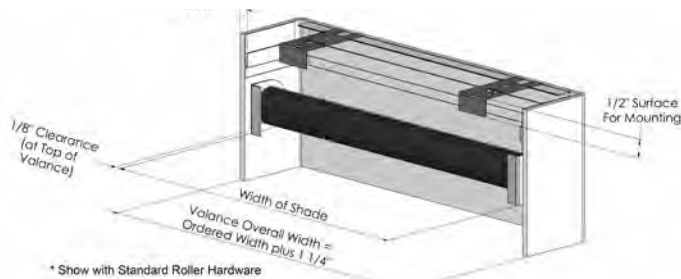

Figure B

Outside Mount

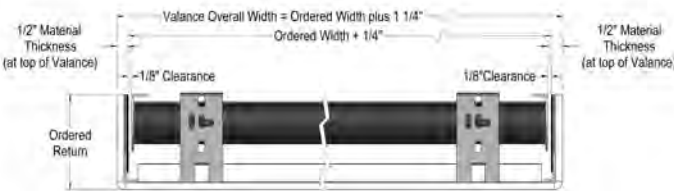

Figure C

Custom Stand Alone Valance with Return Size Options

- Measure the width of the area you wish to cover. Be sure to add extra space if you have window trim or extra wall space you'd like to cover. See Figures D-F for measuring information.
- Next, determine the length of your desired returns. Use the chart on page 79 for the mounting depth required and inside valance depth clearance provided for each return size.

Outside Mount

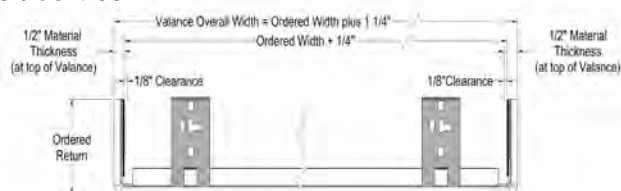

Figure D

Custom Stand Alone Valance with Return Size Options

(Cont.)

Inside Mount

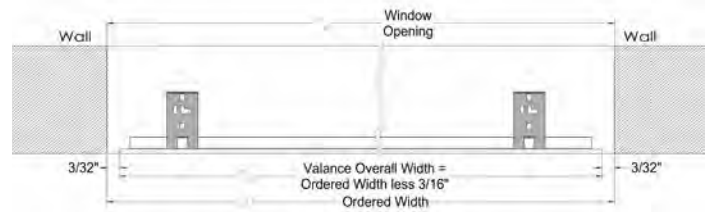

Figure E

Shallow Mount

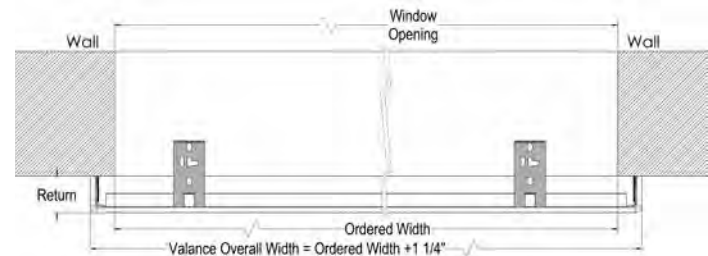
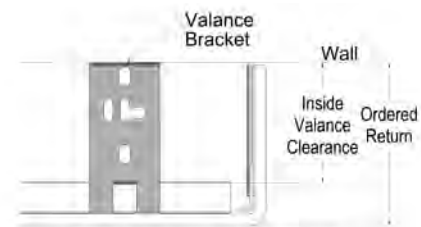

Figure F

Valance Returns

- Seven return size options are available when ordering a Highlights Valance as a stand alone product.
- **Return Sizes:** To determine a return length, add the component dimensions (mounting brackets, etc.) up to the wall. Subtract the measurements from any protrusions (molding, etc.), then choose from one of the pre-determined return application sizes (from the chart on page 79 that best fits your application).
- **Return Coverage**
Ordered return size refers to the distance from the face of the valance to the back of return. See Figure G.



Return dimensions are measured from the face of the valance to the wall.

Figure G

Clearances

Shallow Mount Bracket

- 1 1/2" Return provides an inside valance clearance of 7/8".
- 2" Return provides an inside valance clearance of 1 3/8".
- 2 1/2" Return provides an inside valance clearance of 1 7/8".

Outside Mount Bracket

- 3" Return provides an inside valance clearance of 2 3/8".
- 4" Return provides an inside valance clearance of 3 3/8".
- 5" Return provides an inside valance clearance of 4 3/8".
- 6" Return provides an inside valance clearance of 5 3/8".

COLOR LUX® ROLLER SHADES

Color Lux® Highlights Cornice Valance with Keystone

Keystone Specification

- All keystones will automatically be wrapped with matching Color Lux Roller Fabric.
- Available in Classic Duck, Linen and Solar Screen 5.
- Keystones will be provided separately and installed on site.
- Ordering two optional keystones is currently not available. Two keystones may be required for some wider width valances.
- Valance panels are divided in half when the Keystone option is ordered. Custom locations for keystone placement is not available.

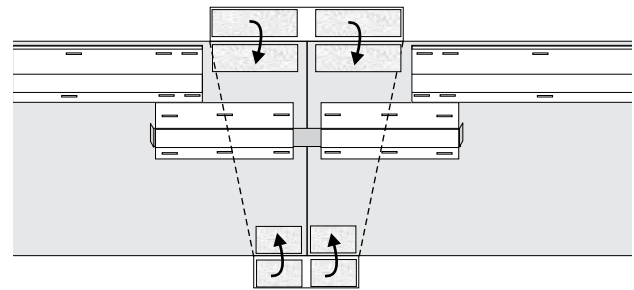

Rear view of the Highlights Valance Keystone. Not visible to room side.



Front view of the Highlights Valance Keystone.

Keystones for Panel Tracks

- Keystones ordered for Panel Tracks should use the return sizes list below to ensure clearance of the Panel Track Rail.
- **2 Panels Side or 4 Panel Split = minimum 3" returns**
- **3 Panels Side = minimum 3" returns**
- **4 Panels Side or 6 Panel Split = minimum 4" returns**
- **5 Panels Side or 8 Panel Split = minimum 4" returns**

COLOR LUX ROLLER SHADES

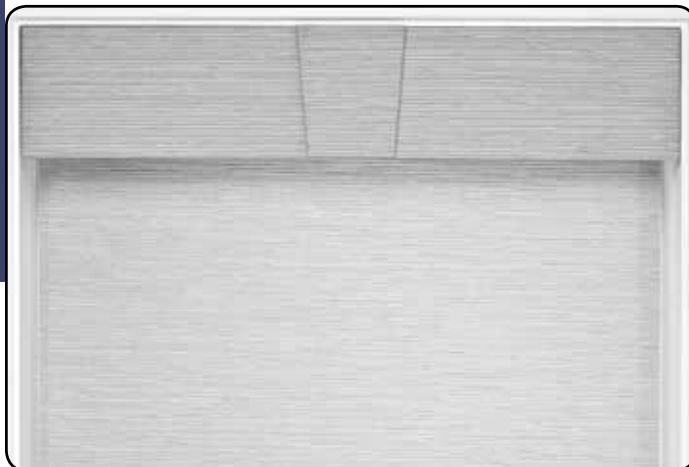

A Keystone option is available for all shade widths so every Highlights Valance in a room will be uniform

Color Lux Custom Graphics for Highlights Cornice Valance.

Custom Graphics is available for Highlights Cornice Valance without a Keystone only.

- Available in Classic Duck Light Filtering, Classic Duck Blackout, and E - Screen 5%. (E Screen 5% is only available on Custom Graphics).
- Add 25% to Standard Rectangular Price on page 79.

COLOR LUX® ROLLER SHADES

Color Lux® Cornice from Designer Window Solutions

Color Lux Designer Window Solutions now offers a beautiful new cornice option using Color Lux Linen and Sateen drapery fabrics. Available in heights ranging from 6" to 16", with return sizes from 1 1/2" to 7" is sure to fit any application in the home. They are designed to coordinate beautifully with all Color Lux solid colors and are a perfect top treatment for other hard or soft window treatments.

See the 2018 Color Lux Designer Window Solutions Manufacturer's Price List and Reference Guide for more information!

Color Lux® Roller Retractable Cord Shades with Designer Cassette

The Retractable Cord system for Color Lux Roller Shades is a perfect option for hard to reach shades when a continuous loop is not desired. The retractable cord system features smooth and easy to use operation. The Designer Cassette option is required for all Retractable Cord shades.

Colors

Clutch: is available in White or Black. Can be coordinated with any Designer Cassette option.

Cords and Tassels: White or Black

Operation

The clutch can be ordered to the right or left of the shade so the pull cord is easy to reach.

To raise, simply pull the cord straight down until it reaches full extension and then allow the cord to retract completely into the head rail. Each stroke partially raises the shade. The shade can be stopped at any point while raising.

To lower, simply pull the cord out towards you until it reaches full extension and then allow the cord to retract completely into the head rail. Each stroke partially lowers the shade. The shade can be stopped at any point while lowering.

Light Gap

Please note that there is a 3/4" light gap on the operation side of all roller shades.

Minimum ordered width for Retractable Cord shades is 12". See fabric specification pages for maximum sizes.



3/4" light gap on operation side. Clutches are available in white and black with tassels and cords in white or black

Color Lux Retractable Cord Pricing Example:

36 x 60 Linen Light Filtering Fabric: $\$294 \times 2 = \588

Add Retractable Cord Surcharge: \$40

Total List Price Before Dealer Discount = \$628

Color Lux® Dual Roller Shades

Dual Roller Shades

Dual Roller Shades are available with Skyline Cord Loop and Simplicity Rechargeable Motorization. They are the perfect way to combine both light filtering and blackout fabrics into a single shade for the ultimate light control. Any fabric or screen in the Envision Fabric collection can be mixed and matched to create a versatile window for any time of day.

The front roll of fabric is always a reverse roll. The back roll of fabric is always a standard roll. Clutches are always on opposite sides of the shade to ensure a location for tensioner mounting.

Dual Roller Shades are not available with cordless operation or PowerTouch Rechargeable motorization. Bracket covers are not available. Brackets are available in black and white.

Candeling will occur between the upper and lower fabric rolls if a Blackout fabric is selected as the back roll. This allows light to come through. Blackout fabric can be selected for the front roll to prevent this.

Simplicity Rechargeable Motorization is available with Dual Roller Shades to ensure easy installation without the need to mount two battery wands.

See price grids for Dual Roller Shade Specifications. Shade minimums and maximums are identical to single shade systems. Not available with 2" tube.



Candeling when Blackout Fabric is selected as the back roll.



Tensioners are mounted on opposite side of a Dual Roller Shade



Distance between rollers when front shade is raised all the way

DUAL ROLLER SHADE PRICING EXAMPLE:

For Satin Nickel Dual Roller Shades:

Front Shade 36 x 60 Linen Light Filtering: \$294

Back Shade 36 x 60 Linen Blackout: \$326

Satin Nickel Skyline Clutch Surcharge: $\$27 \times 2 = \54

Add Dual Roller Shade Surcharge: \$27

TOTAL LIST PRICE BEFORE DEALER DISCOUNT = \$701

Two-on-One Head Rail for Color Lux™ Roller Shades

Two on One Head Rail roller shades are two roller shades sharing the same head rail; each roller operates independently.

Operating Options

- Two on One Head Rail can be combined with cord loop, PowerTouch Motorization, Simplicity Motorization and Simplicity Rechargeable Motorization hardware options.
- Controls will always be placed to the far left and far right. (Controls are NOT available between two shades)

Fabric Options

- Two on One Head Rail roller shades are in both Classic Duck Light Filtering and Classic Duck Blackout for Color Lux Roller Shades
- See price grids for standard size limitations.



Head Rail Options

- Available with Designer Cassette or Standard Roller Shades.
- Two on One roller shades are ONLY available on 1 1/2" tube.
- Available with Designer Cassette with Insert Strip and Smooth Face options.
- Fabric wrapping is NOT available on two on one Designer Cassette.
- Minimum single section is 12".
- Maximum single section is 106" for Classic Duck Light Filtering and Classic Duck Blackout fabrics
- Total maximum width in Designer Cassette head rail is 140". Maximum shade sizes will vary by fabric
- Center gap between roller shades is 3/8".

TWO ON ONE CASSETTE PRICING EXAMPLE:

36" x 60" Classic Duck Blackout Fabric	\$294 x 2 = \$588.00
Designer Cassette Insert Strip	\$86 x 2 = \$172.00
PowerTouch Motorization:	\$99 x 2 = \$198.00

Total List Price Before Dealer Discount: \$958.00

- Specify shade total width and the two individual section widths. **Please Note:** The two individual sections must add up to the total width.

TWO ON ONE NO CASSETTE PRICING EXAMPLE:

For Satin Nickel Two-on-One No Head Rail Shades with PowerTouch Rechargeable:

36 x 60 Linen Light Filtering Fabric:	\$294 x 2 = \$588
Add Satin Nickel Skyline:	\$27 x 2 = \$54
Add PowerTouch Rechargeable:	\$99 x 2 = \$198

Total List Price Before Dealer Discount = \$840

Two-on-One No Head Rail Shades

The Two-on-One No Head Rail mounting option uses an intermediate bracket that reduces the light gap when two shades are placed side-by-side.

Cord Loop shades will always have the clutch on the outside of both shades to ensure proper tensioner mounting.

Standard Brackets are available in White, Black, Ivory and Bronze. Intermediate Brackets are available in White, Black and Ivory.

Bracket covers for the two outer shades are the same colors available for a Skyline Standard Roller Shade: White, Black, Ivory, Bronze and Satin Nickel.

Two-on-One No Head Rail Shades are available with Cord Loop, Simplicity Motorization, Simplicity Rechargeable Motorization and PowerTouch Rechargeable shades.

PowerTouch Rechargeable wands will always hang to the outside of each Two-on-One No Head Rail shade.

COLOR LUX® ROLLER SHADES

Cordless Options for Color Lux™ Roller Shades

Cordless Roller Shades with Designer Cassette

Create a sleek look with the Designer Cassette Head Rail. Available in White, Ivory, Black, Satin Nickel and Bronze. See individual fabric specifications for minimum and maximum shade sizes. Cordless Roller Shades with Designer Cassette are available with the Smooth Face, Fabric Insert or Fabric Wrapped options.



Designer Cassette with Smooth Face in White



Designer Cassette with Smooth Face in Ivory

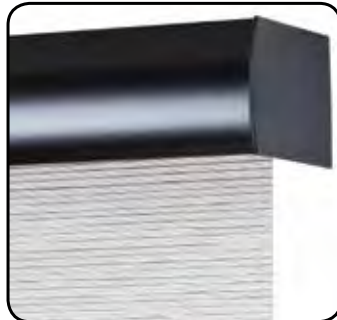

Designer Cassette with Smooth Face in Black

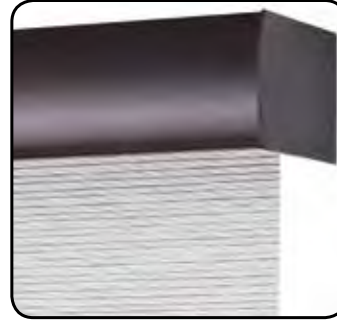

Designer Cassette with Smooth Face in Oil Rubbed Bronze



Designer Cassette with Smooth Face in Satin Nickel

Cordless Roller DecoBar

This cord-free system operates like a spring roller shade with a gentle tug on the bottom rail to raise and lower the shade. See page 77 for mounting information and finished dimension information. Reverse roll is available for the Deco-Bar Cordless option



White Cordless Roller Deco-Bar



Black Cordless Roller Deco-Bar



Ivory Cordless Roller Deco-Bar



Bronze Cordless Roller Deco-Bar



Satin Nickel Cordless Roller Deco-Bar

Cordless Roller Deco-Bar Bracket Covers

The Cordless Roller Decobar now offers deco bar covers in White, Ivory, Black, Satin Nickel and Bronze that coordinates with the deco-bar color selected. Available for Inside Mount or Outside Mount applications. Brackets are White and Black only.



Bracket cover provides a clean finished appearance

Cordless Operation for Color Lux™ Roller Shades

Cordless Tassels and Pulls

Add a decorative tassel or pull to help facilitate easy operation and keep the fabric on the bottom rail clean on all Cordless Shades. Tassels and pulls are placed in the middle of the bottom rail. They feature an approximately 3-inch long cord which coordinates with the tassel color.

Tassels and pulls are attached to the back of the bottom rail with a clear clip. This allows for in the field modifications if needed.

Clear Handle for Cordless Roller Shades

A clear handle comes included with all cordless roller shade orders with an option to attach the handle during installation. This easy to attach and easy to remove clear handle is a great way to keep the rail or the fabric (for fabric wrapped option) clean and new after regular shade use. The width of the handle is 2 1/8" wide.



Optional Clear Handle

ALL Color Lux Roller Shade hardware is available with any Tassel or Pull.

Wood Ball Pulls

Add a decorative Wood Ball Pull to help facilitate easy operation and keep the fabric on the bottom rail clean on all Color Lux Roller Shades. Select from 4 colors: Waxed, Natural, Whitewash and Cocoa.

Add: \$17 Per Shade



Cocoa

Whitewash

Waxed

Natural

Beehive Pulls

Add a durable and fashionable Beehive Pull to your shades for easy lifting and lowering. These are a great combination with solar shades and are available in White and Onyx.

The Beehive pull is 2 5/8" long.

Add: \$40 Per Shade



Onyx

White

Wood Tassels

Select from 5 colors: Milky White, Ebony, Walnut, Light Pine or Mahogany.

A wood tassel is 1 5/16" long.

Add \$17 Per Shade



COLOR LUX® ROLLER SHADES

Cord Loop Operation for Color Lux™ Roller Shades

Color Lux Roller Shades with Standard or Skyline Cord Loop Standard Cord Loop vs. Skyline Cord Loop

	Standard Roller System	Skyline Roller System
White Clutch	X	X
Black Clutch	X	X
Ivory Clutch		X
Bronze Clutch		X
Satin Nickel Clutch		X
White Bracket Covers	X	X
Black Bracket Covers	X	X
Ivory Bracket Covers		X
Bronze Bracket Covers		X
Satin Nickel Bracket Covers		X
Two-on-One No Head Rail		X
Side-By-Side Shades		X
Dual Roller Shades		X
3" Fascia	X	
4" Fascia	X	X
Metal Bead Chains (Steel and Bronze)	X	X

Color Lux Roller Shade Cord Loop Information

Color Lux Roller Shades are available with a choice of colored bead chain colors.

- Select white, black, bronze or steel bead chain with the Standard Roller, Fascia, and Designer Cassette head rail options.
- The bead chain will measure the length indicated below unless otherwise specified.

SHADE HEIGHT	LOOP DROP
12" to 15 ⁷ / ₈ "	² / ₃ of shade height
16" to 29 ⁷ / ₈ "	³ / ₄ of shade height
30" - 35 ⁷ / ₈ "	24" Loop
36" - 41 ⁷ / ₈ "	30" Loop
42" - 47 ⁷ / ₈ "	36" Loop
48" - 53 ⁷ / ₈ "	42" Loop
54" - 59 ⁷ / ₈ "	48" Loop
60" - 65 ⁷ / ₈ "	54" Loop
66" - 71 ⁷ / ₈ "	60" Loop
72" - 77 ⁷ / ₈ "	66" Loop
78" - 89 ⁷ / ₈ "	72" Loop
90" - 101 ⁷ / ₈ "	84" Loop
102" - 113 ⁷ / ₈ "	96" Loop
114" - above	³ / ₄ of shade height

- Bead chain can be ordered in custom lengths. Maximum bead chain length is 15 feet.

Tensioners for Cord Loop Shades

Cord Loop Roller Shades feature a new tensioner design for easy mounting and smooth operation. Available in five finishes that matches the clutch control on Skyline Cord Loop roller shades, now every part of a Skyline Roller shade will coordinate from top to bottom.



White Tensioner



Black Tensioner



Satin Nickel Tensioner



Ivory Tensioner



Bronze Tensioner

Color Lux® Roller Shade General Information

Reverse Roll on Color Lux Roller Shades

A reverse roll option is available at no extra charge with all Color Lux Roller Shade fabrics only on the Standard Roller Hardware and Cordless Roller with Deco-Bar Hardware. The reverse roll allows the fabric to roll off the front of the roller instead of the back (the traditional style). The reverse roll conceals the roller for a contemporary, tailored appearance.



White Cordless Roller with Deco-Bar in Standard Roll



Black Cordless Roller with Deco-Bar in Standard Roll



White Cordless Roller with Deco-Bar in Reverse Roll



Black Cordless Roller with Deco-Bar in Reverse Roll



Standard Roller in Standard Roll



Standard Roller in Reverse Roll

Bottom Rail Options

Color Lux Roller Shades can be built with your choice of 2 bottom rail options:

- Fabric Wrapped Bottom Rail (standard)
- Exposed Bottom Rail

Choose your bottom rail color when ordering.

Fabric Wrapped Bottom Rail

The shade fabric is wrapped around an elliptical grooved rail. Two clear plastic end caps secure the fabric in place. Select from bronze, white, vanilla, black or brushed aluminum.

Choose your bottom rail color when ordering.



Fabric Wrapped Bottom Rail

Exposed Bottom Rail

Select from bronze, white, vanilla, black or brushed aluminum bottom rail to add a decorative accent to the bottom of your shade. Two clear plastic end caps secure the fabric in place.

Choose your bottom rail color when ordering.



Bronze Exposed Bottom Rail

COLOR LUX® ROLLER SHADES

Color Lux™ Simplicity Rechargeable Roller Wave with Designer Cassette

Simplicity Rechargeable Roller Wave

The Simplicity Wave Motor features a roller motor with integrated batteries. Simplicity Wave requires a Designer Cassette option and uses a telescoping wand to raise or lower the shade.

The Simplicity Rechargeable Roller Wave option is available in all sizes in Section 1 of each fabric price grid.

Please Note:

- Not all motors run at the same rate of speed.
- Simplicity Rechargeable Roller Wave shades are programmed at the factory with the "up" and "down" limits.
- Order at least one charger.

Telescoping Wand

- Extends to 33" for hard to reach shades.
- Wand retracts to 9" for easy storage.
- Wand is silver with white handle and white magnetic tip.
- Wall mount plate included for convenience.
- Wand is universal and will operate all Simplicity Wave shades.



Battery Charger

8.4 Volt charger requires a standard power outlet to recharge the battery integrated within the motor. Must specify charger when ordering a PowerTouch Rechargeable shade. The charger plugs into the charger port. The charger is black and comes with a 156" (13') wire.



Mounting Requirements for Simplicity Rechargeable Wave with Designer Cassette

No special installation hardware or wiring requirements are needed to install Simplicity Wave Roller Shades with Designer Cassette Head Rail. A battery wand is not required.



Simplicity Wave for Roller Shades

Standard Color Lux Discounts apply to motorized lift systems pricing.

Motor

- Radio Frequency Motor \$110.00
Includes integrated rechargeable battery

Simplicity Wave Wand

- Telescoping Wand \$29.00

Simplicity Rechargeable Motor Battery Charger

- Charger for rechargeable motors (required): \$26.00

Color Lux™ PowerTouch™ Rechargeable for No Head Rail and Designer Cassette

Color Lux Roller Shades can be fabricated with the PowerTouch™ Rechargeable option.

The PowerTouch™ Rechargeable provides an easy, cord free motorized operation for the budget savvy homeowner. PowerTouch™ Rechargeable uses Simplicity motors and components.



- PowerTouch™ Rechargeable is available for Roller Only and Designer Cassette
- The Roller Only option uses Skyline Hardware brackets and bracket covers available in White, Ivory, Black, Satin Nickel and Bronze. Wand and Pendant are always White or Black.

Color Lux Roller Shade PowerTouch™ Rechargeable Upgrade Surcharges

All standard discounts apply to PowerTouch™ Shades.

- | | |
|--|---------|
| • PowerTouch™ Rechargeable Pendant and Wand: | \$99.00 |
| • Charger for PowerTouch™ Rechargeable (required): | \$26.00 |

PowerTouch™ Rechargeable Roller Shade Specifications

See specific fabric price grids for minimum and maximum shade widths and lengths. Shade sizes in grey shaded sections are NOT available with the PowerTouch™ Rechargeable option.

PowerTouch™ Rechargeable Shades Operation

Press the up or down button on the pendant to raise or lower the shading to your desired position.

Programming the upper and lower limits is completed at the factory. These can be easily adjusted in the field if desired.

Programming the favorites position is completed after shade installation.

Please refer to the installation instructions at comfortex.com/comfortex-dealers.

PowerTouch™ Rechargeable Appearance

- The PowerTouch™ Rechargeable wand and pendant is attached to the head rail and requires no additional mounting.
- The No Head Rail PowerTouch™ Rechargeable wand must be attached to the motor before mounting.
- The wand and pendant hangs down the front of the shades
- The top and bottom buttons lift and lower the shade to the upper and lower limits. The center button is the favorites and stop button.
- The wand does not touch the fabric.
- Pendant is 2½" long.

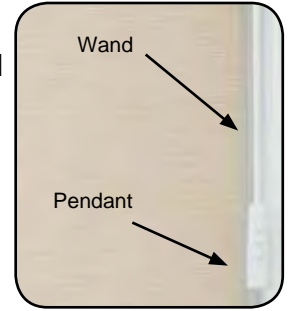

PowerTouch™ Rechargeable Color Options with Designer Cassette and No Head Rail Roller



White



Black

- Shades with Black or Oil Rubbed Bronze head rail will be built with black wand and pendants standard.
- Shades with White hardware will be built with white wand and pendants standard.
- Shades with Fabric Wrapped Head Rail will be built according to the head rail color selected.
- Shades booked as a no head rail roller will have a prompt to select wand color.

Wand and Pendant Location with Designer Cassette and No Head Rail Roller

The standard location for the wand and pendant is on the right. Please specify when ordering.

COLOR LUX® ROLLER SHADES

Color Lux PowerTouch™ Rechargeable for No Head Rail and Designer Cassette

PowerTouch™ Rechargeable Wand Length with Designer Cassette and No Head Rail Roller

Shade Length	Standard Wand Length
Shades up to 30"	1' (12")
30" to 52"	2' (24")
52" to 78"	3' (36")
78" to 100"	4' (48")
100" to 120"	5' (60")

- Custom length wands are not available with PowerTouch™ Rechargeable. Standard wand lengths can be changed at no cost.

Mounting Requirements for PowerTouch™ Rechargeable Shades with Designer Cassette

- No special installation hardware or wiring requirements are needed to install PowerTouch™ Rechargeable Roller Shades with Designer Cassette Head Rail.
- A battery wand is not required with PowerTouch™ Rechargeable shades.

Mounting Requirements for PowerTouch™ Rechargeable Shades with No Head Rail Roller

- On No Head Rail roller shades, the wand must be attached to the motor with two screws (included) before mounting the shade.
- A battery wand is not required with PowerTouch™ Rechargeable shades.

PowerTouch™ Rechargeable Shades Do Not Have a Separate Battery Wand

There is no battery wand with the PowerTouch™ Rechargeable shades. The battery pack is integrated inside the roller tube to make mounting easier and more convenient.

The battery is recharged via the recharging port on the PowerTouch Rechargeable™ Wand.



Recharging Port

Minimum Width Requirements for PowerTouch™ Rechargeable Shades with and without Designer Cassette

Inside Mount = 18³/₈"
 Exact Mount = 18³/₁₆"
 Outside Mount = 18"

Battery Charger

8.4 Volt charger requires a standard power outlet to recharge the battery integrated within the motor. Must specify charger when ordering a PowerTouch Rechargeable shade. The charger plugs into the charger port. The charger is black and comes with a 156" (13') wire.



PowerTouch™ Rechargeable Roller Shades Warranty

Please see page 112 for complete Comfortex warranty information.

Heavy Duty Simplicity Rechargeable Motorization for 2" and 2½" tubes

Heavy Duty Motors are now available for all roller shades that require a 2" or 2½" tube. Motors are only available without a head rail or fascia. Brackets are only white and no bracket covers are available. Can be ordered for smaller shades to maintain consistency, but all tubes will be at least 2".

A 12 Volt charger must be used to recharge heavy duty motors.

Solar Panel option is NOT available for Heavy Duty Motorization.



Spring Loaded Idler



Motorized End

Color Lux Roller Shades with Heavy Duty Motorization

All standard discounts apply.

• Heavy Duty Simplicity Rechargeable Motorization:	\$394.00
• Charger for Heavy Duty Simplicity Rechargeable Motorization (required):	\$54.00

Bracket Dimensions

Projection = 3⁵/₈"
 Width = 3"

Minimum Mounting Depth = 2"
 Minimum Flush Mounting Depth = 3"
 Minimum Side Mounting Depth = 3"



Color Lux® Roller Shades with Simplicity Motorization



Color Lux Roller Shades can be motorized with Standard Simplicity Motorization. The Simplicity Motor program features an option for a battery wand or a DC plug in power supply. Simplicity motors are compact and use a radio controlled remote to raise or lower the shades.

Feature
Remote Radio Frequency Operation
Upper and Lower Limit Stops Pre-Programmed
Battery Wand Standard (uses eight AA batteries)
Plug-in Transformer (DC Power Supply) Available
Intermediate ("Favorite") Position Programming

Head rail styles available with Standard Simplicity Motors:

- Skyline Roller Only
- Designer Cassette
- 4" Skyline Fascia

Standard Simplicity Motorized Upgrade and Surcharges

Standard Color Lux Discounts apply to motorized lift systems pricing.

Motor

- Radio Frequency Motor and Battery Wand: \$289.00

Hand Held Remote

- 5 Channel Remote: \$40.00
- 6 Channel Timer Remote: \$65.00

DC Power Supply - Replaces Battery Wand

- Wall mount transformer DC12V/2A \$63.00

Battery Wand Extension Wires

- 48" Extension Wire \$18.00

The 5 Channel Simplicity Remote can operate up to five shades simultaneously, individually or in groups. **WHEN ORDERING PLEASE SPECIFY WHICH CHANNELS ARE ASSIGNED TO EACH SHADE OR GROUP OF SHADES.**

The 6 Channel Timer Remote can operate up to six shades individually or in groups and has a timer feature to create schedules for automatic shade operation. See page 95 for more information on the 6 Channel Timer Remote.

Steps to Pricing a Motorized Color Lux Roller Shade with Simplicity Motors

- Step 1** Price out Roller Shade at appropriate width and length with desired head rail.
 - Step 2** Add Motor Surcharge.
 - Step 3** Select Remote Surcharge.
 - Step 4** Add all line items for a grand total.
 - Step 5** Apply discount.
- Call Technical Services for assistance with motors.

Simplicity Motors Appearance

Standard Roller Hardware Appearance

Shade Features

- **Bottom rail style:** Fabric Wrapped or Exposed bottom rail
- **Bottom rail color:**
Fabric Wrapped: White, vanilla, bronze, black or brushed aluminum.
Exposed: White, vanilla, bronze, black or brushed aluminum.

The motor lead is 6" long and the battery wire is 10" long.



White and Black Adapters for Skyline Motorization with no head rail

Designer Cassette Head Rail Motor Appearance

This head rail is curved and conceals the shade fabric and motor mechanism with a smooth painted face, insert strip or fabric wrapped option. The battery wand mounts to the head rail.

Shade Features

- **Head Rail Color:** White, Black or Oil Rubbed Bronze with matching fabric strip or smooth face, and Fabric Wrap
- **Bottom Rail Style:** Fabric Wrapped or Exposed Bottom Rail
- **Bottom Rail Color:**
Fabric Wrapped: White, vanilla, bronze, black or brushed aluminum.
Exposed: White, vanilla, bronze, black or brushed aluminum.



The motor lead is 6" long and the battery wire is 10" long.

COLOR LUX® ROLLER SHADES

Color Lux® Roller Shades with Simplicity Motorization

Fascia Motor Appearance

This head rail is rectangular and conceals the shade fabric and motor mechanism with metallic or painted finish. Simplicity motors are available with 4" Skyline Fascia. See page 63 for 4" Skyline Fascia photography.

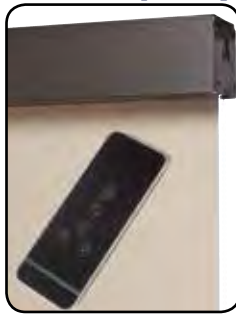

Shade Features

- **Head Rail Color:** Black, bronze, brushed aluminum, white or vanilla
- **Bottom Rail Style:** Fabric Wrapped or Exposed Bottom
- **Bottom Rail Color:**
Fabric Wrapped: White, vanilla, bronze, black or brushed aluminum.
Exposed: White, vanilla, bronze, black or brushed aluminum.

The motor lead is 6" long and the battery wire is 10" long.

Standard Roller, Designer Cassette and Fascia Specifications

See the price grids for motorized shades specifications on pages 64 - 68.

Mounting Requirements For Standard Simplicity Motorized Color Lux Roller Shades

Standard Skyline Roller Hardware

Battery Wand Mounting is Required. See page 70 for mounting information.

Designer Cassette Hardware

Battery Wand Mounting is Required. See pages 72 - 76 for mounting information.

4" Skyline Fascia Hardware

Battery Wand Mounting is Required. See page 77 for mounting information.

DC Power Supply

12 Volt DC power supply is available and requires a standard power outlet to power the motor. The transformer is an alternative to a battery wand. Each transformer can power a single shade with a Simplicity motor. The power supply must plug in to the motor. The DC power supply is white and comes with a 80" wire. The dimensions are 1 7/8" wide x 3 1/4" length x 1 1/4" deep.



Simplicity Motor Battery Wand Mounting

The battery wand is wall or ceiling mounted utilizing white battery wand clips. It also can be clipped to the Designer Cassette head rail.

Batteries are needed to operate Simplicity motors. The battery wand measures 17 1/4" and comes with eight alkaline batteries and is white in color.



Battery Wand

Simplicity Motor Battery Life and Replacement

Eight alkaline batteries are included with the wand. The battery life will vary based on the type of window covering selected, the size and weight of the window covering and the number of times you operate the shade on a daily basis.

Comfortex will warranty batteries for up to 3 months from date of purchase. Batteries are not covered by the limited lifetime warranty.

Simplicity Motor Hand Held Remotes

The Simplicity Remote features 5 individual frequency channels and an All channel which will to operate all the shades at once. **WHEN ORDERING PLEASE SPECIFY WHICH CHANNELS ARE ASSIGNED TO EACH SHADE OR GROUP OF SHADES.** For example; program line 1 to channel 1, line 2 and 3 to channel 2, etc. If no channels are assigned at time of order, all shades will be programmed to Channel 1. To reprogram channel assignments, please refer to the installation instructions and/or view the video at comfortex.com/comfortex-dealers.



The Simplicity remote is available in white or black. All remotes come with a holder which can be mounted to a wall for easy storage.

The remote controls utilizes one 3V battery (CR2430). Batteries are included. Comfortex will warranty batteries for up to 3 months from date of purchase. Batteries are not covered by the limited lifetime warranty.

See page 95 for more information about the Simplicity 6 Channel Timer Remote

Simplicity Battery Operated Motorized Shades Warranty

Please see page 112 for complete Comfortex warranty information.

Color Lux® Roller Shades with Simplicity Rechargeable Motorization

The Simplicity Rechargeable Motorization program features an integrated rechargeable lithium ion battery in the motor casing and is fully concealed by the roller tube.

Simplicity Rechargeable Motorization Upgrades and Surcharges

Motor	
• Radio Frequency Motor: Includes integrated rechargeable battery	\$289.00
Hand Held Remote	
• 5 Channel Remote:	\$40.00
• 6 Channel Timer Remote:	\$65.00
Simplicity Rechargeable Motor Battery Charger	
• Charger for rechargeable motors (required):	\$26.00
Simplicity Smart Controller	
• Smart Controller Unit	\$330.00
Simplicity Solar Panel	
• Solar Panel for Rechargeable Remote	\$75.00
All standard discounts apply to motorized shadings.	

Simplicity Rechargeable Motorization

All Roller Shade Fabrics

Minimum Width: 18"
Maximum Width: See roller price grids for motorized shades specifications on pages 64 - 68.

Simplicity Rechargeable Motors Appearance with No Head Rail Roller and Designer Cassette Head Rail

The Simplicity Rechargeable motor and batteries are concealed within the roller tube.

Mounting Requirements

Standard Skyline Roller Hardware

No special installation hardware or wiring requirements are needed. See page 70 for mounting information.

Designer Cassette Hardware

No special installation hardware or wiring requirements are needed. See page 72 - 75 for mounting information.

4" Skyline Fascia Hardware

No special installation hardware or wiring requirements are needed. See page 76 for mounting information

Simplicity Rechargeable Motor Batteries

The battery for the integrated rechargeable simplicity motor system is integrated within the motor casing and is fully concealed by the roller tube.

Rechargeable battery comes fully charged from the factory.

Battery Wand Mounting is Not Required

No external battery wand is required to operate a Color Lux Roller Shade with Simplicity Rechargeable Motorization.

Simplicity Rechargeable Motor Battery Life

Rechargeable battery is built into the motor.

The average battery charge will last 6-12 months based on an average sized shade raised and lowered once per day. The life of the battery charge will vary based on the type of window covering selected, the size and weight of the window covering and the number of times the shade is operated on a daily basis.

The battery can be recharged up to 500 times. It takes approximately 5 hours to recharge the motor when fully depleted.

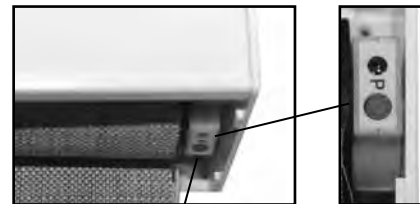

Charging Port

Close-Up

Battery Charger for Simplicity Rechargeable Motors

An 8.4 Volt charger requires a standard power outlet to recharge the battery. The charger must be specified when ordering a Rechargeable Simplicity Motorized shade. The charger plugs into the charging port of the motor.

The charger is black and comes with a 156" (13') wire. The dimensions are 1" wide x 2½" length x 1¾" deep.



COLOR LUX® ROLLER SHADES

Color Lux® Roller Shades with Simplicity Rechargeable Motorization

Simplicity 6 Channel Timer Remote

The 6 Channel (6C) timer remote combines the functionality of a six channel hand-held control with the convenience of a programmable timer.

- The 6C timer remote allows for different scheduled actions each day of the week.
- Manual function disables the timer and the remote then operates as a 6-channel hand held remote.

Simplicity 6C remotes and holders are white in color. The remote comes with a holder which can be mounted to a wall for easy storage. The range of the remote is approximately 80 feet.



THE FACTORY DOES NOT PROGRAM CHANNELS FOR SIMPLICITY RECHARGEABLE MOTORS.

The factory programs the upper and lower limits of every shade. Channel programming is completed after shade installation.

The Standard 5 Channel Simplicity Remote is also available for Simplicity Motorization. See page 93 for more information.

Please Note:

- Not all motors run at the same rate of speed.
- **REMOTES ARE NOT LINKED TO SHADES FROM THE FACTORY. SHADES MUST BE LINKED AFTER SHADE INSTALLATION.**
- Simplicity motors have a "Favorites" position setting. If the homeowner wants to set several shadings at the same intermediate position, follow instructions provided with installation manual.
- **WHEN ORDERING THE SIMPLICITY RECHARGEABLE MOTORIZATION, PLEASE ORDER THE NECESSARY BATTERY CHARGER.**

Important Information about Simplicity Rechargeable Motor Shade Operation and Installation

- Simplicity Motorized Shadings installed into windows with metal casings may have a reduced radio frequency range, or may not operate at all, depending on the application.
- Do not let the antenna on the motor touch any metal objects. This may interfere with signals from the remote control.
- Be mindful of when your shade starts to slow down during operation. It is a good indicator the shade needs to be recharged. The shade will also beep when the remote button is pressed if the battery is low.

New Solar Panel Option

Dimensions: 19" x 1 1/2"

The new solar panel option with mounting brackets plugs into any Simplicity Rechargeable Remote control shade (does not work with PowerTouch).

The solar panel provides a constant trickle charge to 7.4v Li-Ion Rechargeable battery packs. It does not require direct sunlight, but performs best in regular direct sunlight applications.

This option prolongs the life of the charge of the 7.4v rechargeable battery packs, and in some applications will maintain charge indefinitely.

Life of charge is subject to application variables, such as size and weight of the shade, frequency of shade use, amount of direct sunlight exposure, etc.

All standard discounts apply:

- Solar Panel with Mounting Brackets: \$75.00



Color Lux® Panel Track System



COLOR LUX
Designer Cellular & Roller Shades

Color Lux® Panel Track System

The Color Lux Panel Track Shade system offers versatility and a beautiful modern design for effective light control and outstanding performance. Panel track systems are a beautiful option for large windows and room dividers. Available in Classic Duck and Linen Light Filtering and Blackout, and Solar Screen 5.

Stacking Options

Color Lux Panel Track Shades are available with 3 stacking configurations: split, left and right stacks.

- Split stack panels draw open to both sides equally. Controls may be placed on either side and is only available in cord control.
- Side stack is available as left or right stack and is available with a white wand or cord control.



Split Stack



Left or Right Stack



Closed Side Stack

Panel Attachment

A hook and loop strip is sewn onto every panel to provide a secure attachment. The patented panel attach method makes it easy to attach the panels even after installation of the rail.

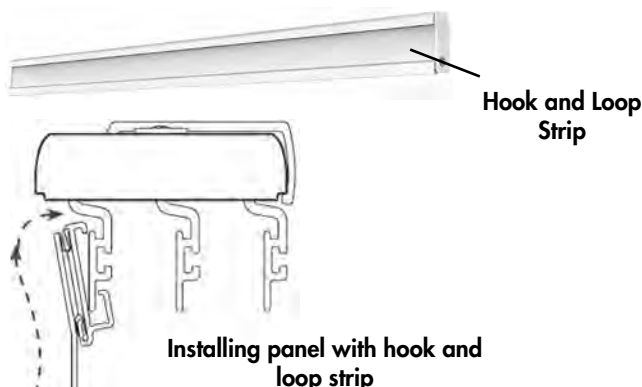

Head Rail Colors

Select from the white or aluminum system hardware system. (Wand is always white.)



White Head Rail



Aluminum Head Rail

Bottom Rail

Panel track bottom rails are designed for smooth operation and allows all panels to glide smoothly past each other.

- Bottom rails are designed to match perfectly with the head rail in exposed white or silver.
- Finished bottom rails will be ½" higher than measured drop on inside mount shades.
- Bottom rails are not connected to each other on this panel track system.
- Fabric Wrapped bottom rails are available as an option.



Fabric Wrapped Bottom Rail

Fabric Panels and Custom Overlaps

Classic Duck Light Filtering and Blackout are both available with the Color Lux Panel Track Shade System.

- Panels will be fabricated with a 2" overlap as standard. Custom overlaps are available at 1½", 2½" and 3". Please specify when ordering.
- Panels are attached with a hook and loop strip to allow for subtle fabric adjustment in the field.
- Each panel traverses the track using ball bearings, creating smooth operation for wand and cord control
- Panels follow a single lead panel in sequence to open and close.
- Panels position exactly behind one another in the open position.
- There is no light gap between the rail and the panels.
- Panels will reach the end of the track.

Please Note: Panels may not hang perfectly flat immediately upon installation. Panels may have a billowing or wavy appearance at the time of installation which may correct itself over time.

Replacement panels are available.

Color Lux® Panel Track System

Control Options

The panel track system uses a cord or wand for traversing the fabric panels. Cord control is standard with every panel track shade. Wand control is available at no additional surcharge. Please specify when ordering.

Cord Control

- The nylon cord is white or grey to coordinate with hardware.
- Standard length of the cord is 10" less the ordered length. Custom cord lengths are available. Please specify when ordering.
- Standard cord placement is right stack with right cord.
- Operating cords are located on the outside edge of the panels.
- Tensioner for cord control is always white.
- Tensioner must always be placed so the cord reaches full extension.



Grey Cord Control

Wand Control

The traversing wand is a convenient alternative to a traditional cord control. This single control system protects children and pets from injuries caused by loop cords.



White Wand Control

- The wand control is always white.
- Only available on side stack systems.
- Standard wand placement is on the outside leading edge of the left or right stack.

Standard Wand Lengths

- Shades up to 72" in Length: 36" wand
- 72" to 96" in Length: 48" wand
- 96" to 120" in Length: 60" wand
- 120" to 144" in Length: 72" wand

Custom lengths are not available but you may select from one of the standard wand lengths above.

Panel Widths

To achieve the best performance on this panel track system, panels are designed within the following parameters:

- The minimum width for a single panel is 6".**
- The maximum width for a single panel is 48".**
- The maximum panel height is 144".**

See price grids for the minimum number of panels that will be available at the desired width.

More panels can be ordered at an additional surcharge and to achieve the desired panel width.

The standard panel overlap is 2". Custom overlaps are available.

Example: The standard split stack on a 96" wide opening would have 4 panels at 26" wide with a 2" overlap. If 6 panels are desired, each panel would be 18" wide.

Track Specifications

- The minimum width of a track is 18".**
- The maximum width of a track is 216".**

The maximum width of a single panel track is 216". When the total width is ordered over 100", tracks will be split in half and a connector bracket will be provided.

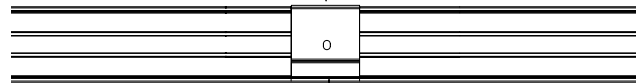

Panel Stack Back

The stack back will be equal to a single panel width. It will never be less than 12" and never exceed 48".

To determine an approximate stack back:

Ordered Width ÷ Number of Panels = Stack Back within +/- 2". (with 2" standard overlap)

Color Lux Custom Graphics for Panel Track

Custom Graphics is available on Panel Track Shades in the following fabrics:

- Classic Duck Light Filtering
- Classic Duck Blackout
- E Screen 5% (only available for Custom Graphics)

Add 25% to Standard Rectangular price plus desired upgrades.

COLOR LUX® PANEL TRACK SHADES

Color Lux® Panel Track Shades

GRID #22

Classic Duck Light Filtering Linen Light Filtering Solar Screen 5
 Classic Duck Blackout Linen Blackout

Center Split Stack
 Standard Cord Draw

Standard # of Panels	Panel Width										
	11"	14"	17"	20"	26"	32"	38"	44"	34"	38"	
Width In Inches											
	36	48	60	72	96	120	144	168	192	216	
Length in Inches	48	666	765	810	910	1115	1271	1477	1623	1728	1829
	60	682	785	831	934	1144	1304	1517	1666	1774	1877
	72	698	804	849	956	1173	1335	1556	1709	1820	1926
	84	713	823	868	978	1202	1368	1595	1750	1866	1974
	96	730	842	888	1001	1231	1402	1635	1795	1912	2022
	108	745	863	908	1024	1260	1435	1673	1836	1958	2071
	120	762	881	926	1047	1290	1468	1713	1880	2005	2119
	132	778	901	980	1070	1319	1536	1752	1958	2087	2206
144	794	920	1004	1092	1349	1572	1793	2005	2136	2258	

Surcharge for Additional Panels										
6 Panels	—	—	32	43	56	69	82	94	—	—
8 Panels	—	—	—	—	112	139	164	188	114	128

Panel Width (Inches) (Approximate*)										
6 Panels	—	—	10"	12"	16"	20"	24"	28"	—	—
8 Panels	—	—	—	—	12"	15"	18"	21"	24"	27"

* Measurements do not account for standard deductions to fabric and head rail and use standard 2" overlap.

**GRID #23 One Way Side Stack
 Standard Cord Draw**

Standard # of Panels	Panel Width										
	20"	26"	32"	38"	34"	42"	38"	44"	40"	43"	
Width In Inches											
	36	48	60	72	96	120	144	168	192	216	
Length in Inches	48	666	765	810	910	1115	1271	1477	1623	1728	1829
	60	682	785	831	934	1144	1304	1517	1666	1774	1877
	72	698	804	849	956	1173	1335	1556	1709	1820	1926
	84	713	823	868	978	1202	1368	1595	1750	1866	1974
	96	730	842	888	1001	1231	1402	1635	1795	1912	2022
	108	745	863	908	1024	1260	1435	1673	1836	1958	2071
	120	762	881	926	1047	1290	1468	1713	1880	2005	2119
	132	778	901	980	1070	1319	1536	1752	1958	2087	2206
144	794	920	1004	1092	1349	1572	1793	2005	2136	2258	

Surcharge for Additional Panels										
3 Panels	23	29	38	43	—	—	—	—	—	—
4 Panels	—	58	77	87	112	70	—	—	—	—
5 Panels	—	—	153	174	224	141	172	105	—	—

Panel Width (Inches) (Approximate*)										
3 Panels	12"	16"	20"	24"	—	—	—	—	—	—
4 Panels	—	12"	15"	18"	24"	30"	—	—	—	—
5 Panels	—	—	12"	14"	19"	26"	29"	34"	—	—

* Measurements do not account for standard deductions to fabric and head rail and use standard 2" overlap.

Additional Surcharges

Scotchgard™ Stain Protection	Add \$50 to the standard rectangular price.
------------------------------	---

Product Specifications

Head Rail Options

- White
- Aluminum

Bottom Rail Options

- White
- Aluminum

Control Options

- Cord Draw (standard)
- Wand Draw (wand is always white)

Panel Size

- Minimum panel width is 6"
- Maximum panel width is 48"

Color Lux® Panel Track System Specifications

Panel Track Finished Dimensions				
	Inside Mount - Cord Draw	Inside Mount - Wand Draw	Outside Mount - Cord Draw	Outside Mount - Wand Draw
Width of Finished Panel Coverage	Ordered Width minus 5/8"	Ordered Width minus 5/8"	Ordered Width minus 3/8"	Ordered Width minus 3/8"
Track	Ordered Width minus 1/4"	Ordered Width minus 1/4"	Ordered Width	Ordered Width
Length	Ordered Length minus 1/2"	Ordered Length minus 1/2"	Ordered Length	Ordered Length

Mounting Options

The following mounting options are available. All mounting brackets are coordinated with the head rail in white or aluminum:

- Wall Bracket with End Caps
- Ceiling Bracket with End Caps

Light Gap

Head Rail/Fabric Panels: There is no light gap between the fabric panels and the bottom of the head rail.

Outside Mount Bracket/Head Rail: There is a 1/4" light gap between the top of the track to the top of the outside mount installation bracket.

Inside Mount Bracket/Head Rail: There is a 1/8" gap between the top of the track to the top of the inside mount installation bracket.

Bottom Light Gap: There will be a 1/2" light gap at the bottom of the hanging panels on an inside mount shade.

Side Light Gap: There will be 3/16" side light gap at the sides of the panel track.

To avoid side light gap on outside mount shades, Comfortex recommends increasing the ordered width by 5", or 2 1/2" on both sides.

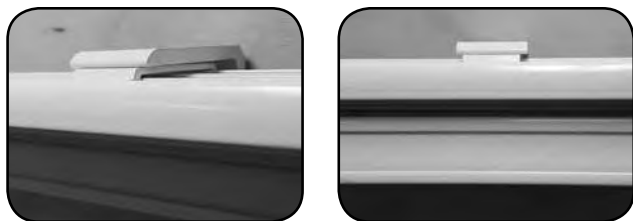

Outside Mount Installation Bracket Appearance

Fabric Deductions and Specifications

Panels are fabricated with a 2" overlap as standard. Custom overlaps are available in 1 1/2", 2 1/2" or 3".

Inside Mount:

Head rail width = ordered width minus 1/4"

Panel height allowance = ordered length minus 1/2"

Outside Mount:

No additional deductions are taken for fabric width

Panel height allowance = ordered length

Highlights Valance for Panel Track with Keystone

See pages 79 - 81 for more information on the Color Lux Highlights Cornice Valance for your Panel Track system.

- Keystones ordered for Panel Tracks should use return sizes list below to ensure clearance of the Panel Track Rail.
- **2 Panels Side or 4 Panel Split = minimum 3" returns**
- **3 Panels Side = minimum 3" returns**
- **4 Panels Side or 6 Panel Split = minimum 4" returns**
- **5 Panels Side or 8 Panel Split = minimum 4" returns**
- Keystones automatically match the color and fabric of the ordered Color Lux Highlights Valance. Custom color options are not available.
- Valance panels are divided in half when the Keystone option is ordered. Custom locations for keystone placement is not available.
- Ordering two optional keystones is currently not available.
- Multiple Keystones may be required for larger widths. (ex. A Highlights Valance with an ordered width of 216" will require TWO Keystone. All three valances will be 72" wide, excluding returns).
- The front panel on a split stack will over lap the back panel as illustrated on page 101.

Highlights Cornice Valance with Keystone for Panel Track Shades

	24	30	36	42	48	54	60	66	72	78	84	94	102	106	112	118	124	130	136	144	150	156	162	168	174	180	186	192	198	204	210	216
Highlights Cornice Valance (No Keystone)	91	101	110	119	130	136	143	150	156	162	169	180	Keystone is required after 94". See pricing below to add a keystone.																			
Highlights Cornice Valance (with Keystone)	122	132	142	150	161	167	174	181	187	193	200	211	227	234	242	251	259	269	278	288	297	305	314	324	334	343	354	365	408	418	432	442

COLOR LUX® PANEL TRACK SHADES

Color Lux® Panel Track System

Clear Window Opening

Panel Tracks are an excellent option for clearing a window opening. Please see the below charts for guidance on what ordered width is recommended to clear a window opening.

For Example:

For a One Way Side Stack ordered with 5 panels, in order to clear an opening of 94", the ordered width of the panel track should be 120".

One Way Side Stack Panel Track

Step 1: Select # of Panels

Step 2: Select uncovered width

2 Panels	If uncovered width is	17	23	29	35	-	-	-	-	-	-
3 Panels	If uncovered width is	23	31	39	47	63	79	-	-	-	-
4 Panels	If uncovered width is	25	34	43	52	70	88	106	124	-	-
5 Panels	If uncovered width is	27	37	47	56	75	94	113	133	152	171
Result: Then Ordered Width is		36	48	60	72	96	120	144	168	192	216

Split Stack Panel Track

Step 1: Select # of Panels

Step 2: Select uncovered width

4 Panels	If uncovered width is	25	34	43	52	70	88	106	124	-	-
6 Panels	If uncovered width is	28	38	48	58	78	98	118	138	158	178
8 Panels	If uncovered width is	30	40	51	61	82	103	124	145	166	187
Result: Then Ordered Width is		36	48	60	72	96	120	144	168	192	216

Panel Configuration - Wand and Cord Control

The lead panel is always in front and catches the panels behind it. Right stack and split stack panel configuration is shown below.

Right Stack
Wand Control

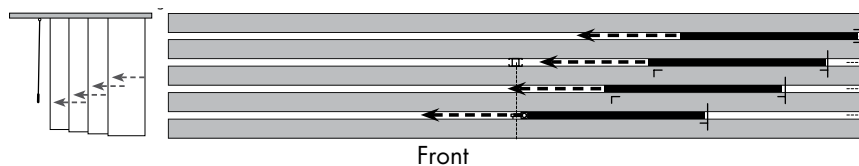

Right Stack
Cord Control

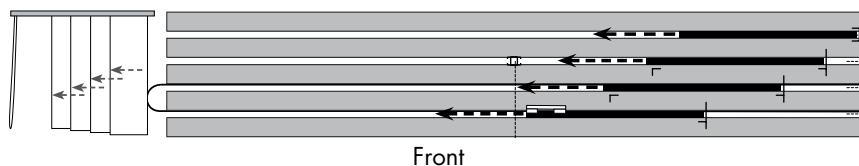

Split Stack
Cord Control

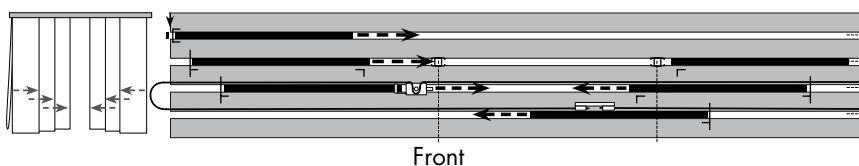

Color Lux® Panel Track System Specifications

Outside Mount Hardware Profiles

Five separate panel track profiles are available depending on the number of panels ordered.

Two Track System

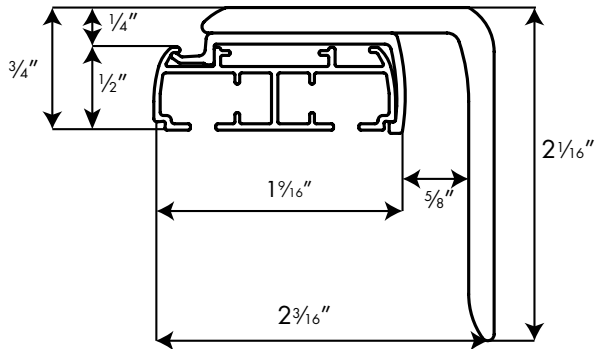

Two channel tracks are used for:
 2 panel side stack
 4 panel split stack

Mounting Dimensions

Minimum height required for outside mounting: 2 1/16"
 Extension Bracket projects back of bracket 2 5/8" from wall

Three Track System

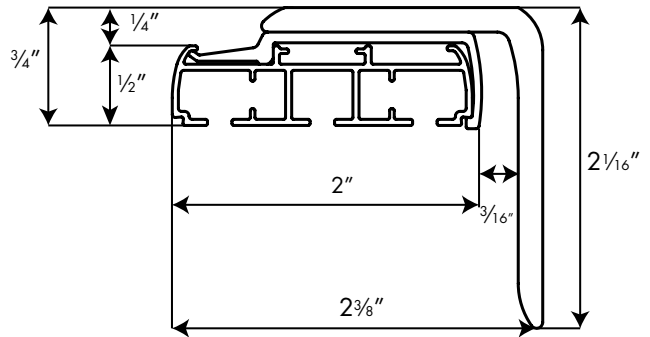

Three channel tracks are used for:
 3 panel side stack
 Not Available for split stack

Mounting Dimensions

Minimum height required for outside mounting: 2 1/16"
 Extension Bracket projects back of bracket 2 3/16" from wall

Four Track System

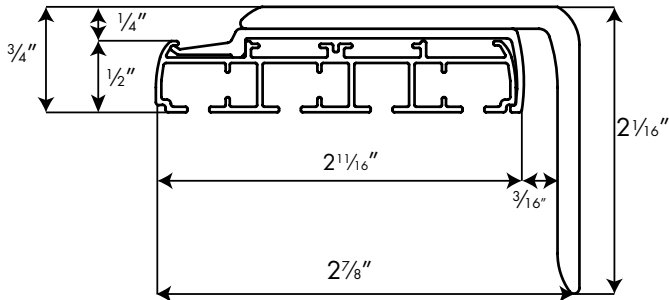

Four channel tracks are used for:
 4 panel side stack
 6 panel split stack

Mounting Dimensions

Minimum height required for outside mounting: 2 1/16"
 Extension Bracket projects back of bracket 1 1/16" from wall

Five Track System

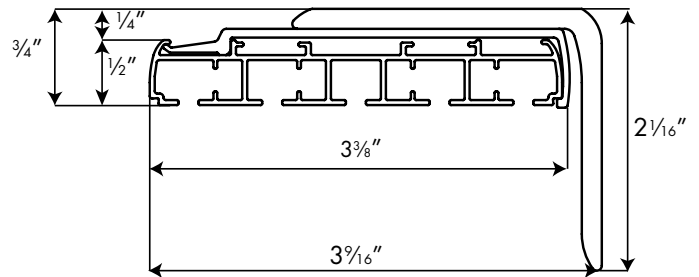

Five channel tracks are used for:
 5 panel side stack
 8 panel split stack

Mounting Dimensions

Minimum height required for outside mounting: 2 1/16"
 Extension Bracket projects back of bracket 1 7/16" from wall

COLOR LUX® PANEL TRACK SHADES

Color Lux® Panel Track System Specifications

Inside Mount Hardware Profiles

Five separate panel track profiles are available depending on the number of panels ordered.

Two Track System

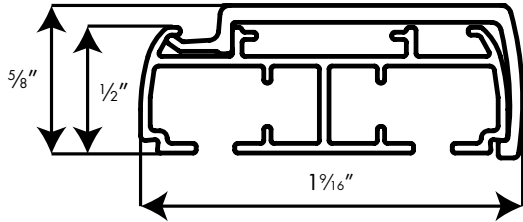

Two channel tracks are used for:
 2 panel side stack
 4 panel split stack

Mounting Dimensions

Minimum depth for flush inside mount: 1 1/16"
 Minimum depth required for shallow mounting: 1 1/4"

Three Track System

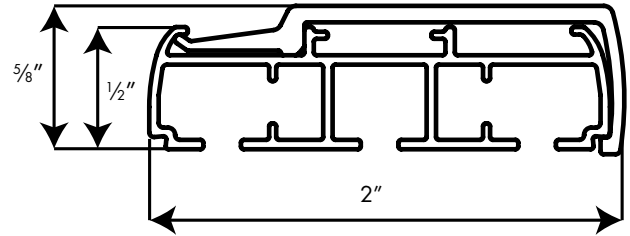

Three channel tracks are used for:
 3 panel side stack
 Not available for split stack

Mounting Dimensions

Minimum depth for flush inside mount: 2"
 Minimum depth required for shallow mounting: 1 7/16"

Four Track System

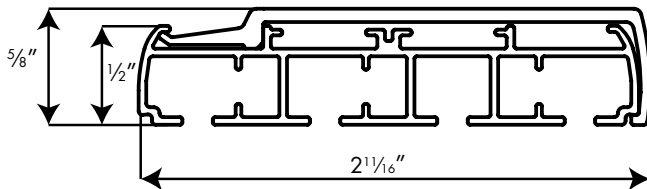

Four channel tracks are used for:
 4 panel side stack
 6 panel split stack

Mounting Dimensions

Minimum depth for flush inside mount: 2 1/16"
 Minimum depth required for shallow mounting: 2 1/16"

Five Track System

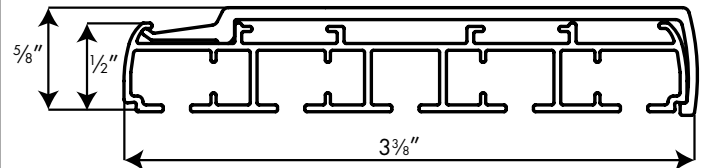

Five channel tracks are used for:
 5 panel side stack
 8 panel split stack

Mounting Dimensions

Minimum depth for flush inside mount: 3 3/8"
 Minimum depth required for shallow mounting: 2 1/4"

Spacer blocks are available at 1/16" increments, up to two. Add to overall projection.
 Example: For a four panel track, take 2 5/8" plus 1/16"

COLOR LUX®

Custom Graphics



Color Lux® Custom Graphics

Print Photos, Logos, Artwork, Advertisements and More on Color Lux® Roller and Panel Track Shades!

With Color Lux® Custom Graphics you can print literally anything on a Color Lux® Roller or Panel Track Shade. From logos and advertisements for a store front, to personal photos and theme room graphics, virtually anything you imagine can be featured on a Color Lux® Roller or Panel Track Shade.

Color Lux® Custom Graphics are also available on Cellular Shades. See the Cellular Price Guide for more information.



Side A
Shows Printed Image

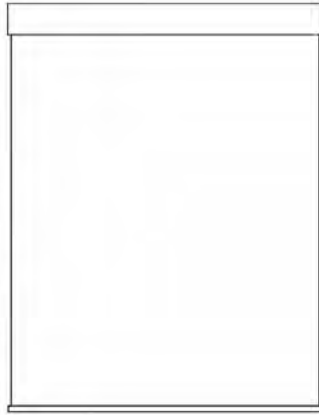

Side B
White Fabric

Single Sided Printing:

- Select a Roller or Panel Track Shade.
- Color Lux® Roller Custom Graphics Shades are available on Classic Duck Light Filtering, Classic Duck Blackout and Mermet E Screen 5%
- (E Screen 5% is only available with Custom Graphic Shades)
- Use the Color Lux Custom Graphics Grids on pages 106 and 107.
- A Color Lux® solid color may be selected for the background color of your shade.
- You can choose to have Side A face the room side or the street side.
- Use the Color Lux® Custom Graphics Order Form

Please Note: When ordering a Color Lux® Panel Track System Shade with a custom graphic, the custom graphic will not line up. The fabric used on Color Lux® Panel Track Shades will be printed at the total width and length specified for the complete system and then will be cut into the number of panels specified. **The pattern on the adjacent panels will overlap by 1½”.**



Side A
Shows Printed Image

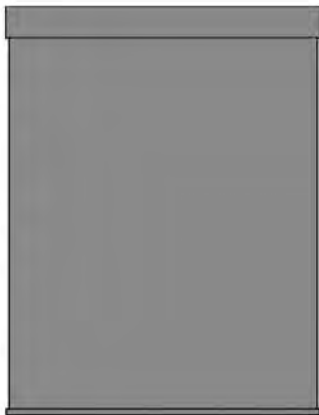

Side B
Solid Printed Color ONLY
(No Graphics)

Double Sided Printing -

Roller Shades on Mermet E Screen 5% Only:

- Double sided printing is available only with Roller Shades.
- Double sided printing is only available on Mermet E Screen 5% Fabric.
- Add the 40% Surcharge to the Standard Rectangular price plus desired hardware options.
- Side A can be any custom graphic.
- Side B can only be a Color Lux® solid color (NO GRAPHICS).
- You can choose to have Side A face the room side or the street side.
- A Color Lux® solid color may be selected for the background color of your shade.
- Use the Color Lux® Custom Graphics Roller Shade Order Forms.

Ordering Color Lux® Custom Graphics Shades

How to order Color Lux® Custom Graphic Shades

STEP 1. FAX OR E-MAIL YOUR ORDER

Fax the appropriate Color Lux® Custom Graphics order form (Roller, Panel Track or Cellular) located on comfortex.com/comfortex-dealers to (800) 336-4580. Or e-mail the order form to customercare@comfortex.com. Upon receipt and review of your order, you will receive a work order confirmation number from Comfortex. Please be sure to reference this number when submitting your artwork in Step 2.

STEP 2. SOURCE AND SEND YOUR GRAPHIC

Source your graphic from a stock photo site such as www.istockphoto.com or use your own high resolution photography. Send your files via e-mail to: customgraphics@comfortex.com OR ship a CD/portable media containing your graphics to:

Color Lux® Custom Graphics
 Comfortex Window Fashions
 21 Elm Street
 Maplewood, New York 12189

Using Online Stock Agencies for Graphics for Your Shades

Sometimes, finding the right graphic or photograph to fit your shade size, shape, or content can be challenging. Fortunately, many web sites offer a great solution. Online stock agencies allow you to purchase reasonably priced, royalty-free digital illustrations, graphics, photographs, patterns, and more in thousands of different subject areas. Some of the more popular sites include:

- thinkstock.com
- istockphoto.com
- veer.com
- shutterstock.com
- gettyimages.com
- 123rf.com
- photosearch.com

Using these sites is easy, simply follow these steps:

Step 1. Create an account and search for your image (i.e. apples).

Step 2. Select, purchase, and download the image you like. You may be given a choice of sizes, so take care to select an option large enough for your needs. Be sure to include the Work Order Confirmation Number received from Comfortex Customer Service with your graphic files.

STEP 3. APPROVE YOUR PROOF

The Color Lux® Custom Graphic Team will email a PDF proof of your shade order which must be reviewed and approved for production to begin. Once the artwork is approved, it will take 2 weeks for your order to be printed, assembled, and shipped.

Color Lux® Graphic File Specifications

Preferred Formats

- Vector files/Adobe Illustrator (AI or EPS)
Please convert all typography to paths prior to submitting your vector artwork.
- TIFF, JPG/JPEG, or Adobe Photoshop (PSD) files with a minimum resolution of 100 pixels per inch at 100% size. For example, a shade measuring 30" x 40" should be supported by a graphic measuring at least 3000 x 4000 pixels.
- Adobe Acrobat (PDF) files created in "Press Quality" or "High Quality Print" with a minimum resolution for all raster elements of 100 pixels per inch at 100% size.

Graphics optimized for, or harvested from the internet are, in general, not suitable for reproduction onto shades.

Comfortex will seek to verify ownership and rights to reprint for all images showcasing copyrighted material.

Questions? Please contact Comfortex Customer Care with all questions regarding Color Lux® Custom Graphic Orders.

E Screen 5% Fabric Properties

Mermet E Screen 5%	TS	RS	AS	TV	OF	SHGC/G Value		Fire Rating	Bacterial & Fungal Resistance	Acoustical Properties	RoHS
						CL - S	DG				
Composition: 36% Fiberglass, 64% Vinyl Width: 98" Weight: 363 g/m ² ± 5% Thickness: 0.41 mm ± 5% UV Blockage: 90%	20	71	9	17	5.00	0.32	0.34	NFPA 701-10 TM#1, California U.S. Title 19	ASTM E2180 ASTM G21	NRC: 0.10 SAA: .012	v

**Color Lux Custom Graphics
Skyline Standard Roller Shade**

E Screen 5%

COLOR LUX® CUSTOM GRAPHICS

		Width In Inches																					
		24	30	36	42	48	54	60	66	72	78	84	90	96	102	108	112	118	124	130	136	144	
Length In Inches	36	299	331	367	408	454	503	559	630	700	778	884	974	1048	1133	1223	1250	1489	1626	1775	1939	2114	
	42	305	340	378	420	467	518	573	648	719	798	906	997	1078	1164	1256	1282	1529	1668	1825	1987	2175	
	48	314	349	389	431	479	533	589	664	739	819	930	1023	1106	1195	1291	1316	1568	1713	1869	2042	2230	
	54	326	357	396	441	490	543	604	681	757	838	956	1048	1136	1226	1324	1353	1609	1757	1917	2093	2297	
	60	331	367	408	453	503	558	618	700	778	862	978	1075	1162	1254	1355	1382	1648	1800	1967	2145	2366	
	66	340	376	419	464	515	572	635	714	794	882	1001	1102	1189	1285	1388	1418	1692	1844	2012	2209	2437	
	72	348	388	428	477	527	585	649	732	814	902	1027	1127	1219	1316	1423	1449	1728	1889	2060	2276	2510	
	78	356	393	440	485	538	598	664	752	832	925	1048	1153	1246	1347	1453	1485	1771	1933	2121	2344	2586	
	84	364	404	446	496	551	613	681	765	851	943	1074	1182	1277	1377	1487	1518	1810	1976	2185	2414	2663	
	90	374	413	458	508	564	626	693	784	871	965	1096	1206	1304	1433	1536	1551	1851	2035	2251	2487	2743	
	96	380	422	468	521	577	638	708	801	886	985	1122	1236	1333	1496	1572	1584	1891	2096	2318	2561	2825	
	102	389	431	477	530	587	653	726	819	910	1007	1146	1259	1360	1533	1604	1631	1948	2159	2388	2638	2910	
	108	395	440	488	539	602	666	740	834	928	1029	1170	1285	1388	1541	1656	1680	2007	2224	2459	2717	2998	
	114	404	446	496	551	613	681	756	851	946	1048	1195	1311	1419	1578	1703							
	120	413	458	508	564	626	693	770	869	965	1070	1216	1339	1446	1604	1767							
	126	420	467	519	577	637	708	784	885	983	1092	1241	1365	1477	1640	1791							
132	431	477	530	587	651	723	801	903	1004	1114	1265	1392	1505	1673	1723								
138	440	485	538	599	664	739	818	922	1023	1136	1291	1421	1536	1699	1750								
144	446	494	549	612	677	753	833	941	1044	1157	1316	1449	1568	1766									

Mermet 5% E Screen: Minimum standard shade size is 12" x 12". Maximum shade width is 120" and can be railroaded to a maximum width of 144" with a maximum length of 108". Mermet 5% E Screen is only available for Color Lux Custom Graphics shades. Double Sided printing is only available on Mermet 5% E Screen.

Head Rail Options and Surcharges

Section 1 & 2	Available: Designer Cassette (All), Cordless Deco-Bar, Fascia (All), Motorization, PowerTouch Rechargeable, Standard Roller, and All Skyline Hardware
Section 3	Available: Standard Roller, Standard Skyline Roller, 4" Fascia, and 4" Skyline Fascia with Cord Loop (Dual Roller Not Available)
Section 4	Available: Standard Skyline Roller Only (Dual Roller Not Available)

Skyline Clutch Surcharge

White, Ivory and Black	No Charge
Satin Nickel and Bronze	Add \$27 to standard rectangular price

Designer Cassette

	24	30	36	42	48	54	60	66	72	78	84	90	96	102	108	114	120
White, Ivory, Black, Brushed Nickel and Oil Rubbed Bronze Includes Smooth and Insert Strip Option	74	80	86	92	98	106	113	120	127	122	129	140	145	149	154	176	198

Fabric Wrapped Designer Cassette is not available with E Screen 5%

4" Fascia with Skyline Cord Loop Hardware

	24	30	36	42	48	54	60	66	72	78	84	90	96	102	108	114	120
White, Ivory, Black, Brushed Nickel and Oil Rubbed Bronze 4" Skyline Fascia	61	67	69	70	80	92	101	111	122	130	142	154	161	170	182	191	200

Cordless Roller

Cordless with Deco-Bar*	Add \$40
Cordless with Cassette	Add \$40 PLUS the Designer Cassette Surcharge to Standard Rectangular Price

*Minimum width is 15½", Maximum width is 96", Maximum length is 96"

Retractable Cord with Designer Cassette

White and Black Retractable Cord	Add \$40 PLUS the Designer Cassette Surcharge to Standard Rectangular Price
----------------------------------	---

Dual Roller Shades

White and Black Brackets	Price as two separate roller shades with desired options. Add \$27 to total.
--------------------------	--

Two on One Head Rail: Price as two separate roller shades with Designer Cassette option and add together.

Highlights Cornice Valance

	24	30	36	42	48	54	60	66	72	78	84	94	102	106	112	118	124	130	136	144
Highlights Cornice Valance (No Keystone)	91	101	110	119	130	136	143	150	156	162	169	180	Requires keystone. See pricing below							
Highlights Cornice Valance (with Keystone)	122	132	142	150	161	167	174	181	187	193	200	211	227	234	242	251	259	269	278	288

Highlights Valance with Keystone: All valances made over 94" wide will require a keystone (shaded area).

Scotchgard™ Stain Protection

Scotchgard™ Stain Protection	Add \$35 to the standard rectangular price
------------------------------	--

Bottom Rail Tassel Pulls: See page 86 for pricing and details.

Motorization: See pages 89 - 95 for all motorization options.

NEW Simplicity Wave for Roller: See pages 76 & 89 for more information.

NEW Solar Panel Option for Simplicity Rechargeable Shades with Remote: See page 95.

NEW Heavy Duty Roller Motors: See page 91 for more information.

Tube Information for Clutch Operated Shades Only

- **Section 1:** Shades to the left of the dashed line requires a 1" tube/SL10" clutch
- **Section 2:** Shades to the right of the dashed line requires a 1½" tube/SL10 clutch
- **Section 3:** Shades in the blue section requires a 2" tube/SL20 clutch.
- **Section 4:** Shades in the orange section requires a 2½" tube/Galaxy 200 clutch

Color Lux® General Information



COLOR LUX® GENERAL INFORMATION

COLOR LUX
Designer Cellular & Roller Shades

Cut-Outs, Scotchgard Protection, Certified Fabrics and Highlights Cornice Valances

Cut-Outs

Cut-outs are available with all cellular fabrics. Cut-outs are \$52.00 per side and are subject to approval by the Comfortex Technical Service department.

There are no limits on cut out lengths. There are limits on cut out widths:

Cellular shade widths 18" or less 3" maximum width

Cellular shade widths greater than 18" 5" maximum width

Scotchgard™ Protection

Scotchgard™ Protector is available with Color Lux Cellular, Roller and Panel Track Shades.

Scotchgard™ keeps your shades looking newer, fresher and cleaner longer.



A combination of the latest advances in stain release and repellency provides exceptional stain protection. Spills wipe away easily and most dirt and stains lift out when cleaned.

Certified Fabrics

GREENGUARD Indoor Air Quality Certified® Fabrics
The GREENGUARD Environmental Institute has established performance based standards to define goods with low chemical and particle emissions for use indoors.

Color Lux Linen Weave fabrics have received GREENGUARD Indoor Air Quality Certified® certification for low emitting interior building materials, furnishings, and finish systems.

Highlights Cornice Valances

Elevate your windows to a whole new level of design with the Highlights Cornice Valance. Coordinate with other design elements in your room and add a finishing touch to the top of any window treatment. The Highlights Cornice Valance is versatile and beautiful at a price point that won't leave you wondering how to cover the rest of your windows!

Choose from any color in the Color Lux Roller line and customize the valance with our 7 available return sizes to best fit your application.

Easy assembly and quick installation, with the Highlights Cornice Valance, more beautiful windows are within your reach.

COLOR LUX® GENERAL INFORMATION

Shade Stack Heights

Measurements are in inches. Shade stacking heights applicable when the shade is in the fully raised position.

	48"	72"	84"	96"
Standard Rectangular (Includes head and bottom rails)	2	2 $\frac{3}{8}$	2 $\frac{5}{8}$	2 $\frac{7}{8}$
Top Down - Bottom Up (Includes head, middle and bottom rails)	2 $\frac{5}{8}$	3	3 $\frac{1}{4}$	3 $\frac{3}{8}$
Cord Loop (Includes head and bottom rails)	3	3 $\frac{3}{8}$	3 $\frac{5}{8}$	3 $\frac{7}{8}$
Motorization (Includes head and bottom rails)	3	3 $\frac{3}{8}$	3 $\frac{5}{8}$	3 $\frac{7}{8}$

	48"	60"	72"	84"
Cordless Ultra (Includes head and bottom rails)	3	3 $\frac{1}{4}$	3 $\frac{3}{8}$	3 $\frac{5}{8}$
Cordless Ultra Top Down - Bottom Up (Includes head, middle and bottom rails)	3 $\frac{5}{8}$	3 $\frac{7}{8}$	4	4 $\frac{1}{4}$
Cordless Lift & Lock (Includes head and bottom rails)	2 $\frac{3}{4}$	3 $\frac{1}{8}$	3 $\frac{3}{8}$	3 $\frac{5}{8}$
Cordless Lift & Lock Top Down - Bottom Up (Includes head, middle and bottom rails)	3 $\frac{3}{8}$	4 $\frac{1}{4}$	4 $\frac{1}{2}$	4 $\frac{3}{4}$

Child Safety

Comfortex has a long history of designing new child-safety products and is proud to provide a leadership role in cooperating with the Consumer Product Safety Commission (CPSC) for the development of policies and guidelines for the industry by serving on the WCMA Standards Development Committee.

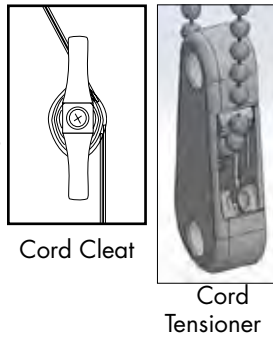

All Comfortex products have been fully tested and proven to comply with the current WCMA Standards for safety of corded window coverings.

Be aware that it is possible for children to become entangled in window covering cords. To reduce the risk of accidents, all cords must be kept out of the reach of children. A cord cleat or cord tensioner is an effective way to implement this essential precaution. Please use them.

To mount the cord cleat at a safe height, take into account furniture or other objects upon which a child may climb. Then, after the use of the blind, simply wrap the excess cord around the cleat.

Cleaning and Care

While beautiful and pleasing to the eye, all Comfortex products are designed to be durable, easily cared for and easily cleaned. Our non-woven fabrics are inherently anti-static and repel dust, but occasional feather dusting or vacuuming may be necessary to keep the fabrics clean and bright. Comfortex Color Lux Cellular fabrics may be ultrasonically cleaned.

Our light filtering and room darkening fabrics are inherently anti-static and repel dust, but occasional cleaning may be necessary to keep the fabrics clean and bright. The fabric can be dusted with a soft, clean cloth, feather duster or lightly vacuumed with a soft brush attachment. Spills and stains can be lightly blotted with a cloth or damp sponge. More difficult stains may require soaking in water with mild soap. For this, remove the shades from the window and soak in warm water. Complete immersion of hardware is not recommended.

DO NOT submerge the Cordless Ultra head rail in water. When damp, lay flat to dry or place back in window and raise tightly to recrisp pleats. Please test any stronger cleaners on an unobtrusive portion of the shade before using.

For additional advice on care or cleaning, please contact our Technical Services Department.

Scotchgard™ Treated Shades

The following are the recommended cleaning and care instructions for window treatments with fabric treated with Scotchgard™ Protector.

- Gently blot liquid stains immediately with a clean, white cloth.
- If stain remains, prepare a solution of ¼ teaspoon of clear, non-bleaching dish detergent mixed with 1 cup of lukewarm water. Dampen a clean white cloth and gently blot the stain.
- Do not over wet the fabric or excessively rub the stained area.
- See the Installation and Care instructions for complete details.

For additional assistance with stain removal, call the Scotchgard™ Protector Service Center at 1-800-433-3296. Customer Care representatives are available Monday through Friday, 8am to 6pm CT.

⚠ WARNING	
	The cords on this product present a potential strangulation hazard.
	For child safety, consider cordless alternatives or products with inaccessible cords.
⚠ ADVERTENCIA	
	Los cordones de este producto representan un peligro potencial de estrangulamiento.
	Para la seguridad de los niños, utilice alternativas sin cordón o productos cuyos cordones sean inaccesibles.
⚠ MISE EN GARDE	
	Les câbles de ce produit représentent un danger potentiel de strangulation.
	Pour la sécurité des enfants, pensez au sans fil, ou procurez-vous des produits dont les câbles ne sont pas accessibles.

Measuring Instructions

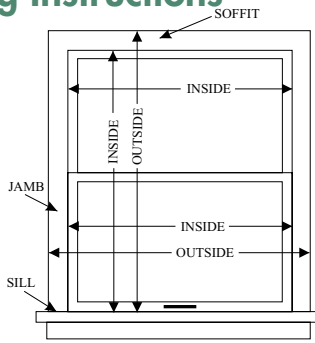

Comfortex accepts measurements down to $\frac{1}{16}$ " increments.

Inside Mount

Use a steel tape to measure the opening at three different places, and use the narrowest dimension when ordering. Be exact! The factory will make the shade $\frac{3}{8}$ " narrower so it will not rub against the window casing. Measure the height of the window from the top (soffit) down to the sill.

Outside or Ceiling Mount

Use a steel tape to measure the exact height and width of the area to be covered. It is recommended that the shades overlap the window by at least $1\frac{1}{2}$ " on each side. When installation has no sill, allow the shade to overlap the bottom of the window casing by at least $1\frac{1}{2}$ ". Shade fabric will measure width indicated on the order form.

Measuring for Specialty Shapes

Templates are required with some specialty shade orders. Consult the individual product sections of this guide for specifics regarding accurate measurements and mounting information.

Arches and Quarter Round Circles

- Measure the window height and width appropriately for an inside or outside mount.
- With perfect arches, the height will be one half the width. With perfect quarter rounds, height will equal width. If the arch or quarter round is perfect, **a template is not required.**
- Windows with imperfect arch measurements do not maintain the height/width relationship. Templates **are required** for these windows.

Trapezoids

- Measure the window height and width appropriately for an inside or outside mount. For outside mounts, remember to add the desired amount of overlap.
- Either the top or bottom of the shade is sloped or angled.
- Measure all four sides for accurate fabrication. Provide all measurements. **Templates are not required.**
- The slope angle must be measured with a protractor. Slope is the angle between slope and a horizontal line. The maximum slope is 30 degrees.

Octagons

- **Templates are required** and must be cut out of brown craft paper.
- Measure the window height and width appropriately for an inside or outside mount. Be sure to measure the width at the shade's widest point.
- Provide the width, length and the length of one side when ordering.

Making the Perfect Template

Tape brown craft paper over the window opening. Be sure to allow plenty of overlap and check to see that the paper is smooth and pulled taut. Do not use newspaper as the ink can rub off on fabric. Do not use paper that has been folded. Notice the outline of the framework superimposed on the template as the light filters through the window. You may create the template in one of two ways:

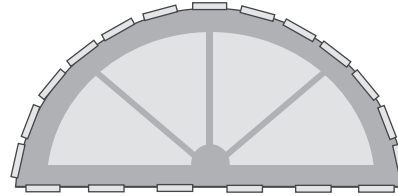

Trace the outline of the window with a pencil and continue along the side of the window frame. Once the window is completely traced, remove the craft paper from the window. Cut out the traced shape with a pair of scissors.

You may choose to skip tracing the window outline with a pencil and cut out the shape immediately with a razor knife.

Once your template is cut, double check its width and height with your initial measurements. Test the template by placing it in the window. Check for light gaps, uneven cutting of curves etc. Trim or remake if necessary.

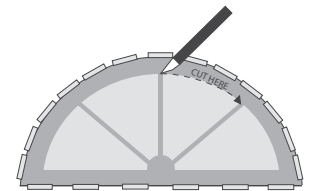

With arch top shades, fold the template in half. Check the outline of the curve for smoothness, light gaps and curve continuity. Place the template in the window and check it for light gaps or uneven cutting of curve. Trim or remake it if necessary.

On the front of the template, mark the shade measurements along with your company name, account number, sidemark, shade style and color. Be sure to indicate inside or outside mount, the room side and which ends of the template are top and bottom. Do not take any deductions on inside mount shades. The factory will make all necessary allowances for inside mounts.

Remember: The quality of the finished shades depends heavily on the quality of the template supplied. Do not hesitate to remake a template if you feel uncomfortable of the quality of your first attempt.

Template Kits: Comfortex offers template kits which includes brown craft paper, razor knife, instructions and order form. Please contact Customer Service or visit www.comfortex.com to order. Stock number: 751000

Conditions of Sale

All Comfortex products are custom fabricated to your exact specifications. We cannot accept responsibility for errors in ordering or cancellations and charges after the order is in production.

Policies

Our policies are designed to provide a guide for doing business with Comfortex. Our first priority and number one policy is to provide the highest level of service and total satisfaction.

Freight

Comfortex will ship all orders for fabricated shades freight free via UPS, FedEx Ground or other similar method within the continental United States*.

A \$3.75 per unit transportation surcharge will be added to all fabricated product orders, within the continental United States, including shades/blinds, vane packs, individual vanes, tracks, valance and cut yardage orders.

In addition, a \$70.00 Common Carrier surcharge** will be added for all orders shipped within the continental United States*, that include shades or blinds with widths of 98" or more and are required to ship by motor freight.

***Hawaii:** Shipments to Hawaii will incur a freight charge of \$50.00 per unit when shipped from within the Continental US.

****In Addition,** a \$110.00 Common Carrier surcharge for oversized shipments will be added to orders shipping to Hawaii.

***Alaska:** Shipments to Alaska will incur a \$6.00 per unit transportation surcharge.

****Alaska Common Carrier Surcharge:** An \$110.00 Common Carrier surcharge for oversized shipments will be added to orders shipping to Alaska.

Canada: Shipments to Canadian dealers will incur a \$3.75 per unit transportation surcharge. In addition, ground shipping charges will be invoiced on a monthly basis as a percentage of the shade order value, together with a \$110.00 Common Carrier surcharge for oversized shipments. Ground Shipping charges are as follows: (\$1.00 to \$1,000 = 7%, \$1,001 to \$5,000 = 6%, \$5,001 to \$10,000 = 5%, and \$10,001 or more = 4%).

Comfortex Mexico Plant: All shipments from our Mexico plant to Alaska, Hawaii or anywhere outside the Continental US will incur all freight charges (freight forwarder needed if shipping to another country).

All Other Countries: All United States dealers requesting to ship orders outside the United States must provide a freight forwarder for Comfortex to ship to within the continental United States. Comfortex cannot ship directly to your customers located outside the United States.

Please Note: Comfortex reserves the right to select another carrier, modify shipping terms or change freight policies without notice.

Charged Marketing Materials

All charged marketing materials will incur freight charges. Marketing materials may ship on separate days, from different locations. Freight charges are calculated per package, not per order.

Service and Repair

Service may be obtained by contacting our Customer Service Department. No products, parts, components or other materials will be authorized for return or repair without prior approval from Comfortex. A Return Authorization (RA) may be obtained by contacting our Technical Service Department. In order to provide the quickest service possible, please have your Comfortex Work Order number and original order information available when you call.

Specifications

All Comfortex products are designed and tested to perform as intended within established, published parameters. Requests for "custom fabrication" of products outside of our published specifications may be considered, but are at the discretion of the Comfortex Technical Services department. Restrictions and additional charges apply.

Download installation instructions, order forms or additional price list copies on the Comfortex OnDemand Library or www.comfortex.com in the Dealers Resource Center.

Motorized Color Lux Cellular Shades Warranty

Standard Simplicity and Simplicity Rechargeable Motors

We offer a 5 year warranty on all motors and controls. Specifically, we warrant the Simplicity motors and controls to be free from defects in material and workmanship under normal and proper use for a period of 5 years commencing with the date stamped on each product. If the Simplicity product fails within this 5 year period, we will repair or replace it free of charge through your end product supplier. Batteries are not covered by the warranty.

Color Lux Color Warranty

Comfortex utilizes state of the art technology to provide you Color Lux Shades within 2 Delta-E (DE) of the sample fabrics found in the Color Lux Sample Book. When viewed under different lighting sources such as fluorescent, incandescent, halogen, ultraviolet and others, fabrics may appear different to the eye. Comfortex utilizes the worldwide lighting standards of Daylight 65 (D65) as our official standard for measuring and qualifying color accuracy, because D65 daylight bulbs best represent actual "daylight" illumination. Slight color variations (under 2 DE) are within established industry standard and should be expected.

This warranty is in addition to Comfortex limited lifetime warranty.

Scotchgard™ Warranty

Comfortex Window Fashions provides a limited warranty for fabrics treated with Scotchgard™ Protector against permanent stains for a period of 1 year from the date of original purchase.

This warranty excludes conditions or damages resulting from accidents, alterations, exposure to the elements, and exposure to any and all natural and manufactured excessive heat sources, or failure to follow the Installation and Care instructions. This warranty also excludes fabric submerged in water or cleaning solutions, or treated with household products that may alter or deplete the effectiveness of the treated fabric. In addition, the following types of stains are excluded from this limited warranty: pet stains, bodily fluids, stains caused by wine, bleach, plant fertilizers, acne medication, misuse or abuse. This warranty is not a cleaning contract and does not cover the cleaning of fabrics that are soiled or discolored through daily use. This warranty coverage is limited to residential use and is not transferable.

The following are the recommended cleaning and care instructions for window treatments with fabric treated with Scotchgard™ Protector.

- Gently blot liquid stains immediately with a clean, white cloth.
- If stain remains, prepare a solution of ¼ teaspoon of clear, non-bleaching dish detergent mixed with 1 cup of lukewarm water. Dampen a clean white cloth and gently blot the stain.
- Do not over wet the fabric or excessively rub the stained area.
- See the Installation and Care instructions for complete details.

For additional assistance with stain removal, call the Scotchgard™ Protector Service Center at 1-800-433-3296. Customer Care representatives are available Monday through Friday, 8am to 6pm CT.

Should the results of the cleaning and care instructions not result in the removal of permanent stains covered by this limited warranty, Comfortex will retreat or replace the fabric, at its discretion, for a period of 1 year from the date of original purchase. Customer must provide proof of purchase and provide proof the stain occurred during the warranty period. Shipping and handling costs to send the window treatment back to Comfortex are the responsibility of the customer.

This warranty gives you specific legal rights, and you may also have other rights which vary from state to state.

Color Lux Cellular, Roller and Panel Track Shades Warranty Information

Comfortex warrants that its window treatments will be free from defects in materials and workmanship for as long as the original residential purchaser owns the product, provided that the product was installed properly and in accordance with the installation instructions. The Limited Lifetime Warranty is extended to the original residential purchaser only, in the original window for which it was installed.

The Warranty does not include any conditions or damages resulting from accidents, alterations, misuse, abuse, misapplication, improper handling, installation, repairs, operation, cleaning, exposure to any and all natural and manufactured excessive heat sources. (Excessive heat sources include, but not limited to; magnification of sun light through cubes of glass, heaters of any kind, ovens, candles, lighting fixtures, etc.) This warranty does not cover variation in fabric color, grain, or texture in natural wood products nor excessive warping of wood slats in high humidity areas. Loss of pleating is not covered if the product is not being cycled (held in the raised position a portion of the time). Normal wear and tear is not covered.

All moving parts, such as cords and strings (internal and external), will eventually wear out and fabric may fray. Comfortex considers these things as normal wear and tear and will carry a three year Limited Warranty. All fabric, including fabric vanes, panels, inserts, and shades carry a five year Warranty. Fabric cell separation is covered for a lifetime. See Comfortex Standard Return and Repair Policy for more details.

This Limited Warranty does not cover transportation costs to and from the retailer, costs of removal, re-measure, reinstallation of product, or any incidental or consequential damages.

If a Comfortex product is found to be defective in materials or workmanship, we will, at our discretion, repair, replace or refund the cost of a product which fails to conform to this Limited Warranty. Colors vary from lot to lot and may not exactly match sample swatch, sample book, or previous purchases. Discontinued components or color selections will be replaced with the closest equivalent current product. This shall be your sole remedy under this Limited Warranty.

To obtain service, contact the Dealer from whom you purchased the product.

This Warranty is exclusive and in lieu of all other obligations,

liabilities or warranties. In no event shall Comfortex or its licensed fabricators or distributors be liable for incidental or consequential damages, or for any other damage, loss or expense, cost or fee associated with such damage. In some states, exclusions for incidental or consequential damages are not allowable. Comfortex Dealers and Fabricators must use safety devices supplied by Comfortex in accordance with Window Covering Safety Counsel guidelines.

This Warranty gives you specific legal rights, and you may also have other rights, which vary from state to state. Policy is subject to change without notice.

This Limited Warranty is exclusive of commercial use. Contact Comfortex Technical Service for more information. No agent, representative, dealer or unauthorized employee has the authority to increase or alter the obligation of this Warranty.

This Limited Warranty supersedes any previous versions.

©2018 COMFORTEX CORPORATION

™ is a trademark of Comfortex Corporation. ® is a registered trademark of Comfortex Corporation. Scotchgard, 3M and the Plaid Design are trademarks of 3M. The GREENGUARD INDOOR AIR QUALITY CERTIFIED Mark is a registered certification mark used under license through the GREENGUARD Environmental Institute. Energizer® is a registered trademark of Energizer Holdings, Inc. . Ovation™ Cellular Slider is covered by one or more of the following U.S. Patent Nos.: 4,862,941, 4,858,668, 4,915,153, D346,032, D324,108, 4,450,027, 4,631,108, 4,603,072, 5,690,778, 5,664,773, 6,319,586, 5,482,750, 5,601,885 and 4,631,217. Karma-Light™, Cordless Ultra™, Sunset™, and Ovation™ are trademarks of Comfortex Corporation. Other U.S. and foreign patents pending.



Color Lux® Panel Track | Timeless Neutrals | Courtyard Tan

What's Inside:

- Simplicity Rechargeable Motorized Shades
- Roller and Panel Track fabrics
- Fabric Wrapped Hardware Standard on Cellular Shades
- Optional Scotchgard™ Stain Protection
- 800 Color Collection - **Color without Compromise!**



www.midwestdesignersupply.com

888-523-2611
262-524-1007 (fax)



512300PL 04/18
Scotchgard™ is a trademark of 3M.